

USER MANUAL
Refrigerant gas detectors series
GDR

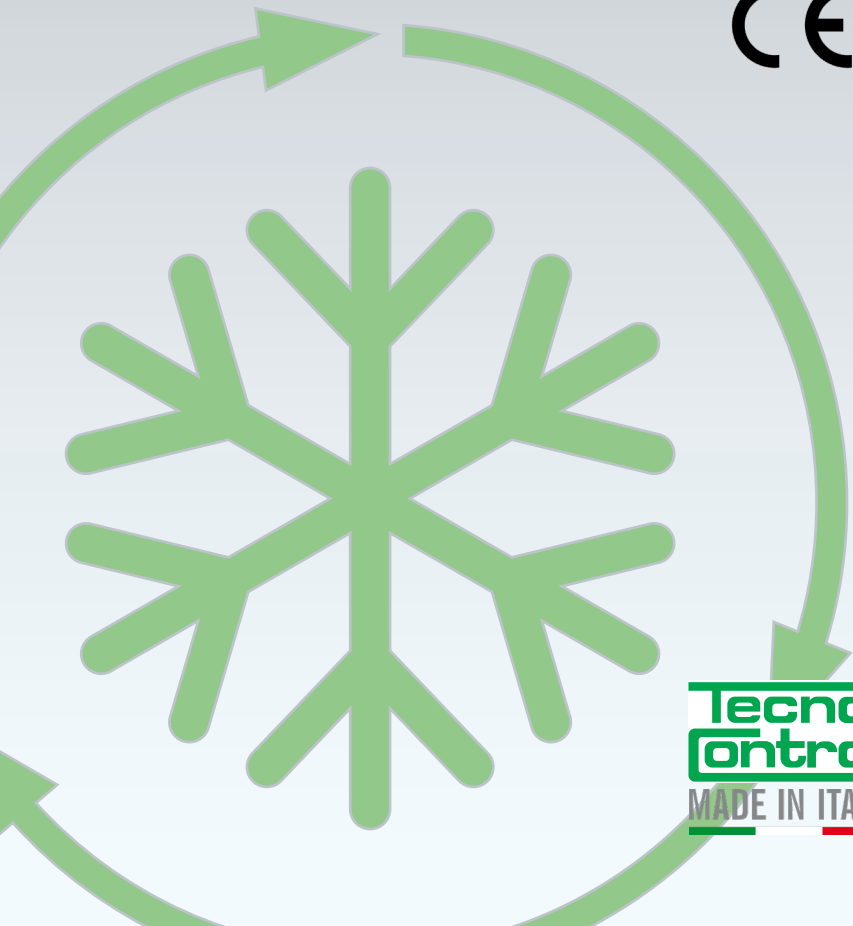

CE



**Tecno
Control**
MADE IN ITALY

- GDR450/453**
- GDR400/403**
- GDR300**
- GDR403/453**



The Use and Maintenance Manual must be kept for the entire life of the device in use, near the device itself, inside a suitable container and, above all, protected from any element or substance that could compromise its perfect readability.

TABLE OF CONTENTS

| | | |
|--------------------------------------|---|----|
| 1 - Information | | |
| 1.1 | General information | 2 |
| 1.2 | Explanations of graphic symbols | 3 |
| 1.3 | General warnings | 3 |
| 1.4 | General description | 4 |
| 1.5 | Product warranty | 4 |
| 2 - Specifications | | |
| 2.1 | Product Specifications | 5 |
| 2.2 | Safe and correct use | 7 |
| 2.3 | Installation | 9 |
| 2.3.1 | General information for installation | 9 |
| 2.3.2 | Electrical connection | 9 |
| 2.3.3 | Wiring | 10 |
| 3 - Description | | |
| 3.1 | Product Description | 14 |
| 3.2 | Sensor technologies functioning | 14 |
| 3.3 | Start-up | 15 |
| 3.4 | Preheating (warm-up) | 15 |
| 3.5 | Self-testing | 15 |
| 3.6 | Normal operation | 16 |
| Alarm/Fault Conditions | | |
| 4.1 | Over-range conditions | 16 |
| 4.2 | Warning | 17 |
| 4.3 | Fault conditions | 17 |
| 5 - Menu and PASSWORD | | |
| 5.1 | PASSWORD management | 19 |
| 5.2 | PASSWORD change | 20 |
| 6 - Language selection | | |
| | | 20 |
| 7 - Detector configuration | | |
| 7.1 | Sensor cartridge data display | 21 |
| 7.2 | Gas to be detected setting | 21 |
| 7.3 | Alarm relays setting | 22 |
| 7.4 | RS485 setting | 23 |
| 7.5 | Bluetooth Activation/Deactivation | 23 |
| 8 - Detector maintenance | | |
| 8.1 | Electrical test | 24 |
| | Calibration gas table | 25 |
| 8.2 | Calibration concentration setting | 26 |
| 8.3 | <u>ZERO calibration</u> | 26 |
| 8.4 | Models with display (GDR450/453) | 26 |
| 8.5 | Models without display (GDR300/400/403) | 27 |
| 8.6 | <u>SPAN Calibration</u> | 28 |
| 8.6.1 | Models with display (GDR450/453) | 28 |
| 8.6.2 | Models without display (GDR300/400/403) | 29 |
| 9 - Bump test | | |
| 9.1 | Modell with display (GDR450/453) | 30 |
| 9.2 | Modell without display (GDR300/400/403) | 30 |
| 9.3 | Table of alarm output relays | 31 |
| 10 - Dimensions and weight | | |
| | | 32 |
| 11 - Tecnocontrol Application | | |
| 11.1 | Configuration | 33 |
| | | 34 |
| Note | | 35 |

1 - **INFORMATION**

1.1 **GENERAL INFORMATION**

This manual was drafted by the manufacturer of the equipment and is an integral part of it.

This manual defines the purpose for which the equipment was designed and constructed and contains all the information necessary to ensure its safe and correct use.

Compliance with the instructions contained therein guarantees personal safety and a longer life of the equipment itself.

The information contained in this manual is addressed to the following subjects:

- personnel in charge of transport, handling, unpacking;
- personnel involved in the preparation of the systems and the installation site;
- installers;
- user of the equipment;
- maintenance personnel.

This manual must be kept with the utmost care and always made available for any consultation: it must therefore be protected from moisture, carelessness, sunlight and anything else that may damage it. For a quick search of the topics, see the table of contents on the previous page.

Important warnings and parts of text have been highlighted by using the graphic signs illustrated and defined below.

1.2 **EXPLANATION OF GRAPHIC SIGNS**

The following symbols indicate the risk arising from non-compliance with the corresponding safety precautions as specified below.



General hazard

warns that non-compliance with the prescription entails the risk of damage to property and injury to animals, and/or people.



Obligation – read the manual

The user is required to read the “instructions for use” manual before putting the appliance into service.



Recycling

indicates that the materials can be disposed of in accordance with current regulations



Management of waste of electrical equipment

indicates that the equipment cannot be assimilated to solid urban waste, but must be disposed of in accordance with current laws.



Indicates that the text placed nearby was deemed important information.

1.3 **GENERAL WARNINGS**

The manufacturer shall not be held liable for any damage caused to the flammable gas detector or to property in the following cases:

- improper use;
- use of unsuitable personnel;
- incorrect assembly and installation;
- defects in the systems;
- unauthorised modifications or interventions to the product;
- use of non-original spare parts;
- non-compliance with the rules set out in this manual;
- exceptional events.

Any operation not described in this manual and/or not authorised by the manufacturer, in addition to immediately invalidating the warranty, entails full responsibility on the part of the person carrying it out.

1.4 **DESCRIPTION**

The refrigerant gas detectors of the GDR series are devices that detect the presence of refrigerant gases by means of semiconductor (MOS), electrochemical, Pellistor (catalytic) and infrared (NDIR) sensors. They are used in central alarm systems for refrigerant gas industries, laboratories, cylinder storage warehouses, compressor chambers, and environments where it is necessary to monitor any refrigerant gas leaks. The code of each model identifies the type of gas detected and its upper limit of the scale. The detector consists of a case containing the electronic circuit, the replaceable sensor cartridge and the connection terminals.

The "Replaceable Sensor Cartridge" contains the sensitive element with the identification and calibration data for the specific gas detected.

The refrigerant gas detector product, type "GDR450, GDR453" has a window with backlit display, five LEDs and the keys for non-intrusive configuration and maintenance operations.

The refrigerant gas detector product, type "GDR300, GDR400, GDR403" has five LEDs and the keys for non-intrusive configuration and maintenance operations.

These sensors constantly monitor the quality of the surrounding air, detecting the presence of specific gases through (LEDs) indicators that show the concentration of the detected gases in real time. If safety thresholds are exceeded, the sensor also activates audible alarms via a buzzer, a function available only in versions equipped with a relay board. Furthermore, the device can provide continuous and precise signaling via a 4÷20mA analog output or digital communication via the MODBUS RS485 protocol, allowing integration with remote monitoring systems or industrial control devices.

1.5 **PRODUCT WARRANTY**

The warranty applies to products that present manufacturing or assembly defects, according to the judgment of the manufacturer's technicians.

The warranty does not cover parts subject to wear and breakage due to misuse and non-compliance with the rules contained in this manual.

The warranty period is 24 months from the delivery date for the electronic part and 12 months for the sensitive part. The warranty is void in the event of improper use of the product.

The use of non-original "Tecnocontrol" spare parts will invalidate the warranty.

Tecnocontrol will not be liable for damages or inconveniences caused by the failure to comply with the rules contained in this manual.

The warranty is provided ex works; therefore, the costs for transporting the equipment under warranty from the customer to the manufacturer and vice versa are not covered.

The warranty is void in the event of:

- obvious tampering with the product;
- changes made to the product without prior written authorisation from Tecnocontrol;
- repairs carried out by staff not authorised by Tecnocontrol;
- the serial number has been altered or deleted or the Tecnocontrol brand has been deleted.

2 - SPECIFICATIONS

2.1 Product specifications

Refrigerant gas detectors, type "GDR300", "GDR450", "GDR750" are classified as follows:

- type of equipment: continuous operation equipment.
- sensor:
 - catalytic combustion (pellistore)
 - electrochemical
 - infrared (NDIR)
 - semiconductor (MOS)
- Operating temperature: -40°C to 60°C
- Humidity: 0% to 95% RH (non-condensing)
- Storage temperature: -20°C to 55°C
- type of signal/alarm: **- RS485 interface output (ModBus).**

- Analog output 4 ÷ 20 mA

Note: Custom NAMUR standard is used. The standard considers as:

- 1 - Values below 3,6 mA and above 21,0 mA are faulty.
- 2 - The customisation consists of detecting the fault for values below 2,4 mA (in order to allow concentration reporting up to -10%FS).

- **Analogue output in voltage mode** (GDR4xx models) 1÷5V; 2÷10V Note: Use the selector **7** positioned on the electronic board to set the analogue output in voltage mode or 4 ÷ 20mA (see INSTALLATION chapter).

- **Relay outputs:** Relay AL1, AL2, and FAULT (1A - single switch Max 24Vdc)

- **Optical/acoustic signals:** AL1, AL 2 and power FAILURE ON (●), alarms AL (●), FAULT (●), bluetooth (●) Buzzer integrated (GDR4xx models only).

| Model | OUTPUT | | | | |
|-------------|----------|-------|----------------|-------|--------|
| | 4 ÷ 20mA | RS485 | Analog Voltage | RELE' | BUZZER |
| GDR 450/453 | ✓ | ✓ | ✓ | ✓ | ✓ |
| GDR 400/403 | ✓ | ✓ | ✓ | ✓ | ✓ |
| GDR 300 | ✓ | ✓ | | | |
| GDR 403/453 | ✓ | ✓ | ✓ | ✓ | ✓ |

- Wireless interface: Bluetooth
- Electrical power supply:
 - 11 ÷ 30 Vdc
 - 12 ÷ 24 Vac (+10 / -15%)
 - 230Vac - 50/60Hz (+10 / -15%) (on request)

Attention: For technical specifications refer to the product plate data.

- fastening method: on the wall or on the support bracket. (Be careful to protect the device from excessive vibrations).
- installation site: exterior and interior.
- degree of protection: IP 67 (GDR450/453 - GDR400/403-GDR300-GDR403/453)
IP 66 (GDR750)

■ Power consumption:



| POWER SUPPLY | GDR300 | | | |
|--------------|----------|----------|----------|----------|
| | GDR300 S | GDR300 I | GDR300 P | GDR300 E |
| 30Vdc | 2,0W | 2,2W | 2,3W | 1,6W |
| 24Vac | 1,9VA | 2,3VA | 2,3VA | 2,4VA |



| POWER SUPPLY | GDR400-403 | | | |
|--------------|------------|----------|----------|----------|
| | GDR40x S | GDR40x I | GDR40x P | GDR40x E |
| 30Vdc | 2,9W | 3,4W | 3,0W | 2,1W |
| 24Vac | 2,7VA | 3,1VA | 2,8VA | 2,1VA |
| 230Vac | 3,5VA | 4,2VA | 4,0VA | 3,0VA |



| POWER SUPPLY | GDR450-453 | | | |
|--------------|------------|----------|----------|---------|
| | GDR45x S | GDR45x I | GDR45x P | GDR45xE |
| 30Vdc | 3,2W | 3,7W | 3,3W | 2,4W |
| 24Vac | 3,0VA | 3,4VA | 3,1VA | 2,4VA |
| 230Vac | 3,8VA | 4,5VA | 4,3VA | 3,3VA |

S = Semiconductor - **I** = Infrared - **P** = Pellistor - **E** = Electrochemical

■ Front screws tightening torque: 1,5/2,0 Newton

■ Attention :

- Refrigerant gas detectors, type "GDR300 - GDR4xx" cannot be used as a legal measuring device pursuant to Directive 2014/32/EU "MID".

- The refrigerant gas detectors, type "GDR300 - GDR4xx" are safety aids.

2.2 SAFE AND CORRECT USE

For safe and correct use, keep these important warnings in mind:

- Any operation not described in this manual and in the instructions and/or not authorized by the manufacturer, in addition to immediately voiding the warranty, entails full responsibility on the part of the person who performs it.
- Perform the detector Bump-Test with sample gas every 3 months / 6 months to ensure that the filter on the sensor is not dirty or damaged and to check correct operation of the sensor and the signalling interfaces.
- Perform the detector Electrical Test every 3 months / 6 months to ensure that the 4-20mA interface and/or the 1-5V 2-10V analog interface signal 0mA/0V correctly and the relay interface switches correctly.
- Never exceed the maximum relay load capacity. Consider, in the case of inductive loads, that the capacity of the relay must be at least 3 times as much as the current absorbed by the load. If necessary, place a contactor of suitable capacity between the relay and the load.
- In case of supply voltage below the minimum operating value, the detector will automatically turn off. The interfaces indicate the shutdown status.
- Do not power the detector with a power supply voltage above the maximum operating limit.
- If the sensor is subjected to an amount of gas beyond full scale, it must be checked for correct operation by bump-test or complete calibration (zero + span). This consideration may not apply to infrared sensors.

- Considerations for catalytic/pellistor sensor:

The sensor only works in the presence of Oxygen. Do not use pure gases directly on the sensor as this could cause irreparable damage. Consider that in particularly polluted environments or with vapours of flammable substances (especially solvents), the useful life of the sensor can be greatly reduced. Some substances cause a permanent reduction in sensitivity, avoid the sensor coming into contact with Silicone vapours (present in paints, sealants and greases), Lead Tetraethyl or Phosphate Esters. Other substances cause a temporary loss of sensitivity, these "inhibitors" are Halogens, Hydrogen Sulfide, Chlorine and Chlorinated Hydrocarbons (Trielin or Carbon Tetrachloride). After a short time in clean air, the sensor resumes normal operation.

- Considerations for infrared sensor:

Consider that in particularly polluted environments or with the continuous presence of vapours of flammable substances or above the standard Temperature and Pressure, the lifespan of the sensor may be reduced. Also consider that if the sensor is subjected to vibrations, it may lose accuracy and be damaged.

- Considerations for electrochemical sensor:

The sensor only works in the presence of Oxygen. Do not use pure gases directly on the sensor as this could cause irreparable damage. Warning: electrochemical sensors contain a small amount of acid, potassium acetate which is corrosive. The sensor also contains small amounts of lead, lead oxide, platinum, silver, carbon and antimony. In the event of a leak from the sensor, (caused by a violent mechanical action or use beyond the operating limits) avoid touching the spilled liquid.

If on skin or eyes, wash immediately with plenty of water. Interference with other gases: the device detects gases, in the environment, at a very low concentration. The electrochemical cells used have good resistance to commonly used products such as sprays, detergents, glues or paints. These may contain substances that, in large quantities, could interfere with the sensor; it is advisable to ventilate the room when using these products.

Consider that in particularly polluted environments or with vapours of other substances in very high quantities (in particular organic solvents, hydrogen, alcohols), they can cause false alarms and the sensor must then remain in clean air for a long time to return to normal operating conditions (1-2 hours).

The sensors used have been developed to operate within certain temperature and humidity limits. Prolonged operation outside the established limits may cause damage to the sensor.

The rate at which the sensor gains or loses water is determined by the ambient temperature: water transfer is faster at higher temperatures.

If the sensor is exposed to prolonged extremes of relative humidity at high temperatures over extended periods of time, there is a risk that the sensor's performance may be compromised, potentially resulting in loss of sensitivity, an elevated baseline, or slower response time.

Therefore, if the customer's intended use may expose the sensor to prolonged extreme environmental conditions, it is recommended to consult a member of the Tecnocontrol technical team for further advice regarding the likely implications and how to overcome any encountered issues.

- Additional considerations for electrochemical oxygen sensors:

At very high levels (e.g., percentage levels), strongly oxidizing gases (e.g., ozone, chlorine) will interfere by contributing to the oxygen reading proportionally to their oxidizing power, but most other commonly encountered gases will have no effect.

IMPORTANT NOTE about acidic gases: Acidic gases such as CO₂ and SO₂ will be absorbed by the electrolyte and tend to increase the oxygen flow to the electrode.

This results in an artificially elevated oxygen signal—approximately 0.3% increase in signal for every 1% CO₂. Oxygen CiTiceLs are not suitable for continuous operation in CO₂ concentrations above 25%

- Considerations for semiconductor sensors:

The semiconductor sensor operates only in the presence of oxygen.

Do not apply pure gases directly onto the sensor, as this may cause permanent damage.

Note that extreme humidity conditions, high temperatures, or heavily polluted environments with high levels of organic vapors or flammable substances (particularly solvents), or with very high concentrations of refrigerant gases, can significantly reduce the sensor's lifespan and performance.

Certain substances may cause total or permanent loss of sensitivity; avoid exposing the sensor to silicone vapors (present in paints and sealants).

High concentrations of corrosive substances such as hydrogen sulfide, sulfur dioxide, chlorine, and hydrochloric acid can cause sensor failure. Excessive vibrations or mechanical shock can also damage the sensor.

- Before configuring the detector via the display interface, perform the "electrical test" to verify correct display operation.

- After configuring a parameter via the RS485 – Modbus interface, re-read the parameter through the interface to manually verify its accuracy.

- After configuring a parameter via the Bluetooth - Atp interface, re-read the parameter using the App to manually verify its correctness.

The App should automatically display a pop-up presenting the parameters received by the detector for manual confirmation.



If this does not occur, completely exit the App's configuration menu (return to the main normal operation screen), then re-enter the configuration menu of the parameter to check the current value.

- Regular maintenance is essential for the proper functioning of the equipment. The detector must be maintained as described in this instruction manual.

2.3 **INSTALLATION**

2.3.1 **GENERAL INSTALLATION INFORMATION**

The detectors must be installed, positioned and maintained in accordance with all local standards in force for the electrical systems.

-  The gas detectors in question must be installed in a vertical position. Fastening must be carried out using the appropriate slots.
-  The case cannot be modified or drilled under any circumstances.
-  The installation of the gas detector must only be carried out by qualified and experienced personnel. Improper installation may impair the proper functioning of the device and pose a safety risk. It is recommended to carefully follow the instructions provided and to comply with all local safety regulations."

-  Do not paint the device. If it is necessary to paint the areas around the detector, make sure that the paint does not deposit on the detector.
 - Paint solvents can also cause an alarm condition or cause the sensors to be poisoned.
 - Protect the device from excessive vibrations.
 - Do not place the detector with the sensor head in a position exposed to direct sunlight.
 - Make sure that there is free flow of air around the sensor.

2.3.2 **ELECTRICAL CONNECTIONS**

The maximum distance from the gas detection control unit, to which the transmitter can be installed, is indicated in the Table below (Table 1) depending on the section of the cable and the control unit used.

| Cable section | Cable resistance (Single conductor) | The maximum distance each detector can be installed from the 12Vdc power supply | The maximum distance each detector can be installed from the 24Vdc power supply |
|------------------------|-------------------------------------|---|---|
| 0,75 → mm ² | 26 → Ω/Km | 100 m | 300 m |
| 1.0 → mm ² | 20 → Ω/Km | 150 m | 400 m |
| 1,5 → mm ² | 14 → Ω/Km | 200 m | 500 m |
| 2,5 → mm ² | 8 → Ω/Km | 400 m | 800 m |

(Table 1)

-  **ATTENTION:** Use a shielded cable for all electrical connections (except for relay connections) with the sock grounded only from the center side.

Identify the connections (power, analog, Modbus) and remove the terminal blocks from the PCBA. (The terminal blocks are of the plug-in type and can be removed to facilitate clamping).

To open the detector, remove the four screws of the cover until complete removal.
The opening and connection operations must always be carried out with the detector without power.

2.3.3 - WIRING

▪ **11÷30Vdc / 12÷24Vac:** Extract the (4a) VIN/OUT connection terminal block, which is located on the electronic board, wire the positive (+) and negative (-) wires regardless of the polarity. The clamp (4b) is used only in the case of cascade power supply (VIN/OUT).

A shielded cable must be used for the sections (see Tab.1 chap. ELECTRICAL CONNECTIONS).

A TWISTED BELDEN 9841/9842 or compatible cable must be used for the RS485 BUS connection.

The braided sheath must be grounded only on the central side.

The clamp, Vdc/mA is connected and polarised, it is necessary to remove it to make the connections.

▪ **230VAC (on request):** Extract the connection terminal block (13) VIN, which is located on the electronic board, wire the PHASE and NEUTRAL wires referring to **Figure 4**.

Connection key

VIN :Input power supply voltage.

VOU T :Output power supply voltage.

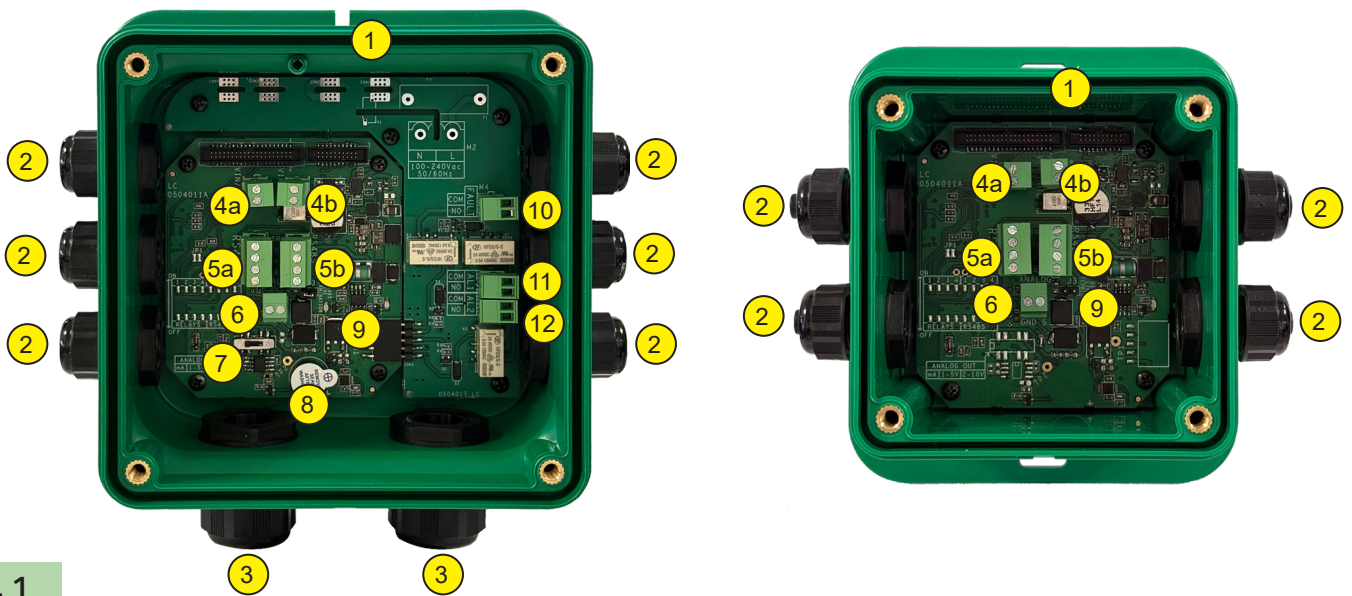

Fig. 1

TIGHTENING TORQUE OF FRONT COVER SCREWS:

Tighten the four front cover screws with a tightening torque of **1,5 to 2,0 Newtons**.

| No. | Reference |
|-----|--|
| 1 | Rubber gasket |
| 2 | M16 cable gland |
| 3 | M20 cable gland |
| 4 | Power supply terminals |
| 5 | RS485 terminals (Modbus protocol) |
| 6 | Analogue output: 4÷20mA / 1÷5 / 2÷10Volt |
| 7 | Analogue output switch: 4÷20mA / 1÷5 / 2÷10Volt |
| 8 | Internal buzzer (present only in models with relays) |
| 9 | JUMPER J3: RS485 End of Line Termination Note: Close only on the last detector on the RS485 BUS. |

| No. | Reference |
|-----|---|
| 10 | Relay connection terminal block (●) FAULT |
| 11 | Relay connection terminal block (●) AL1 |
| 12 | Relay terminal block connection (●) AL2 |
| 13 | Power supply terminal block 230Vac - 50/60Hz (Fig. 4) |
| 14 | Fuse 1A RIT 5x20 (Fig. 4) |
| | |
| | |
| | |
| | |

Details of low voltage supply GDR series connections with relay output:

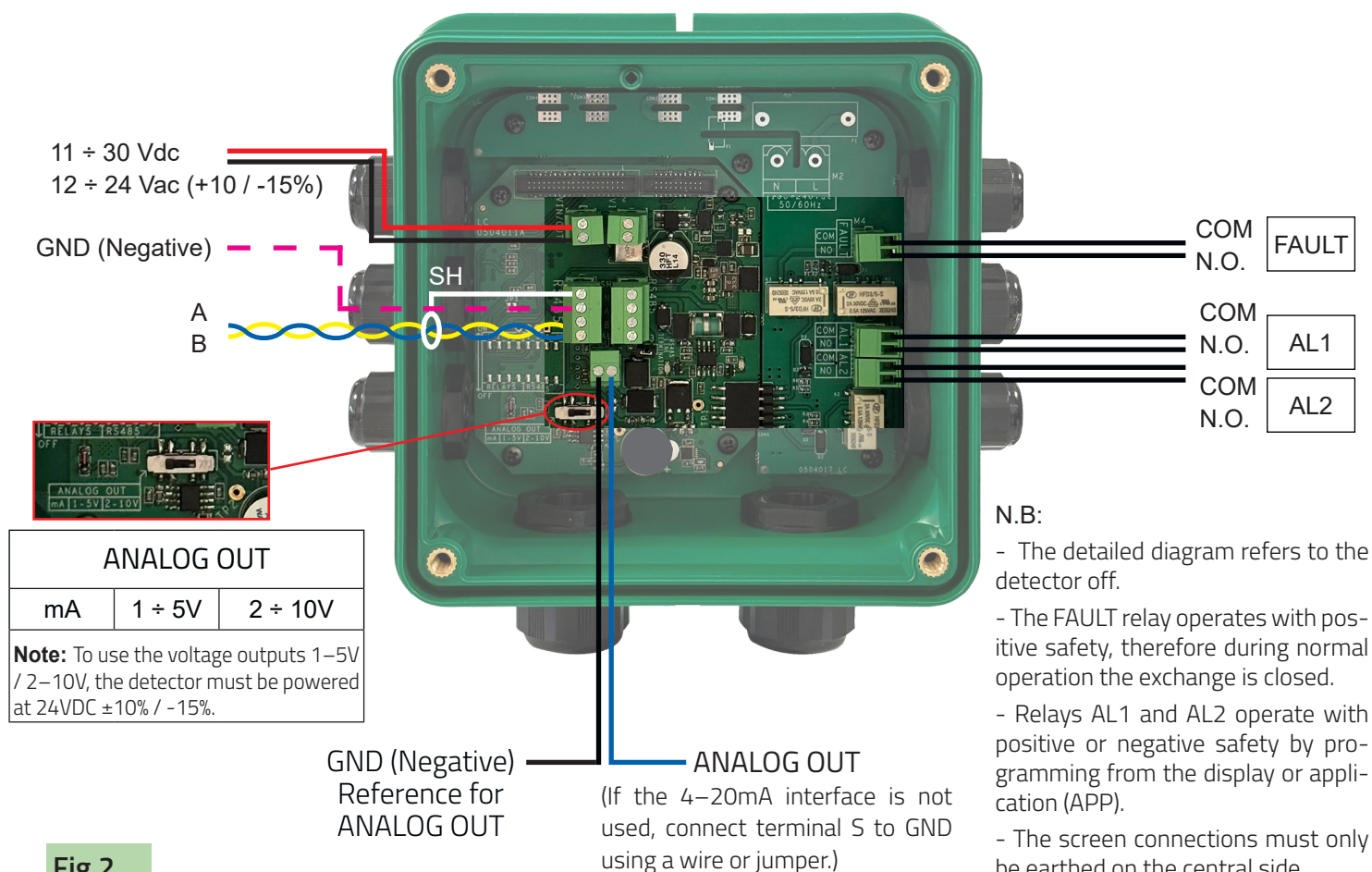
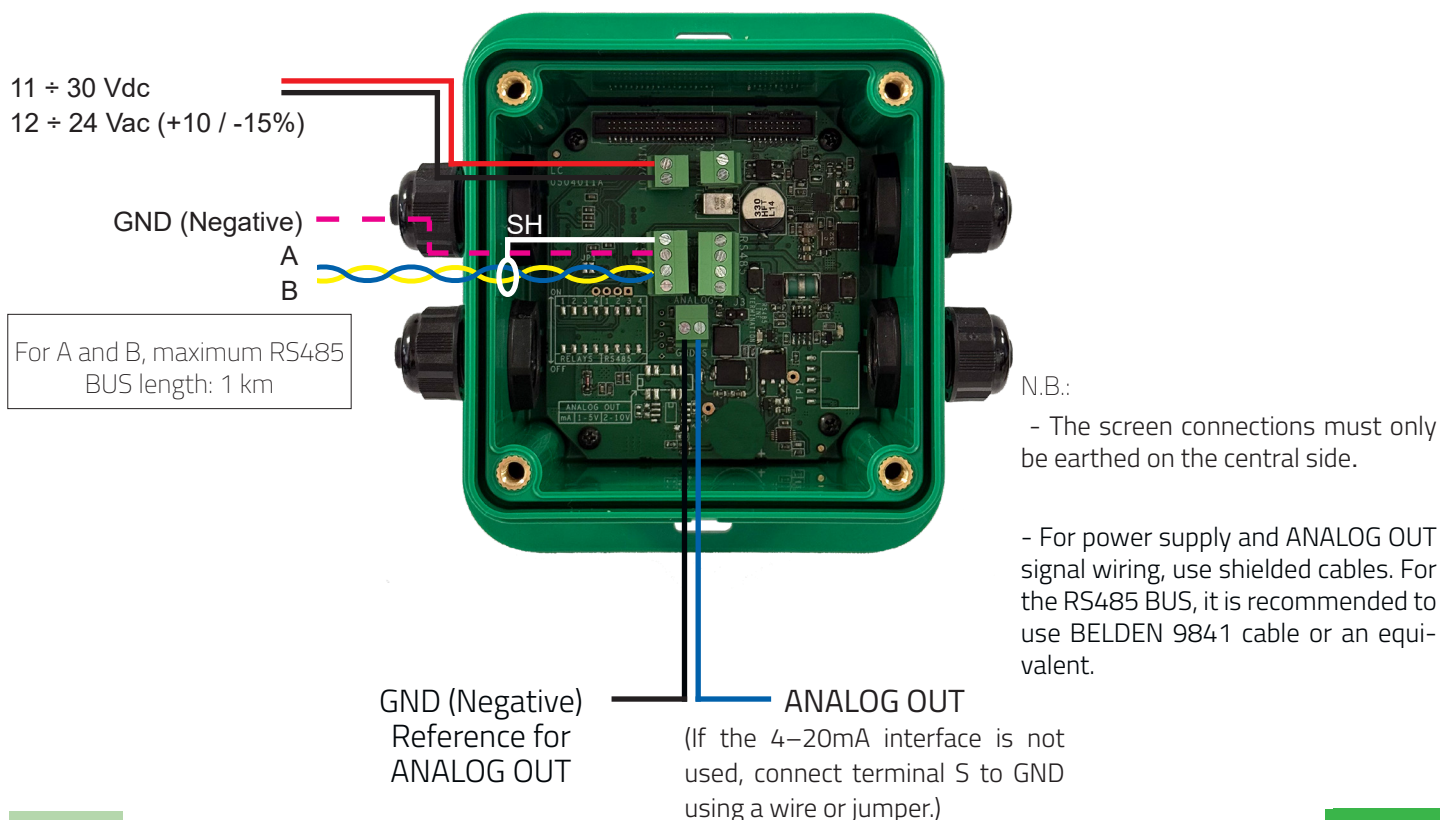

Fig.2

N.B.:

- The detailed diagram refers to the detector off.
- The FAULT relay operates with positive safety, therefore during normal operation the exchange is closed.
- Relays AL1 and AL2 operate with positive or negative safety by programming from the display or application (APP).
- The screen connections must only be earthed on the central side.
- For power supply and ANALOG OUT signal wiring, use shielded cables. For the RS485 BUS, it is recommended to use BELDEN 9841 cable or an equivalent.

Details of low voltage power supply GDR series connections:



N.B.:

- The screen connections must only be earthed on the central side.
- For power supply and ANALOG OUT signal wiring, use shielded cables. For the RS485 BUS, it is recommended to use BELDEN 9841 cable or an equivalent.

Fig.3

Detail of 230V power supply GDR series connections:

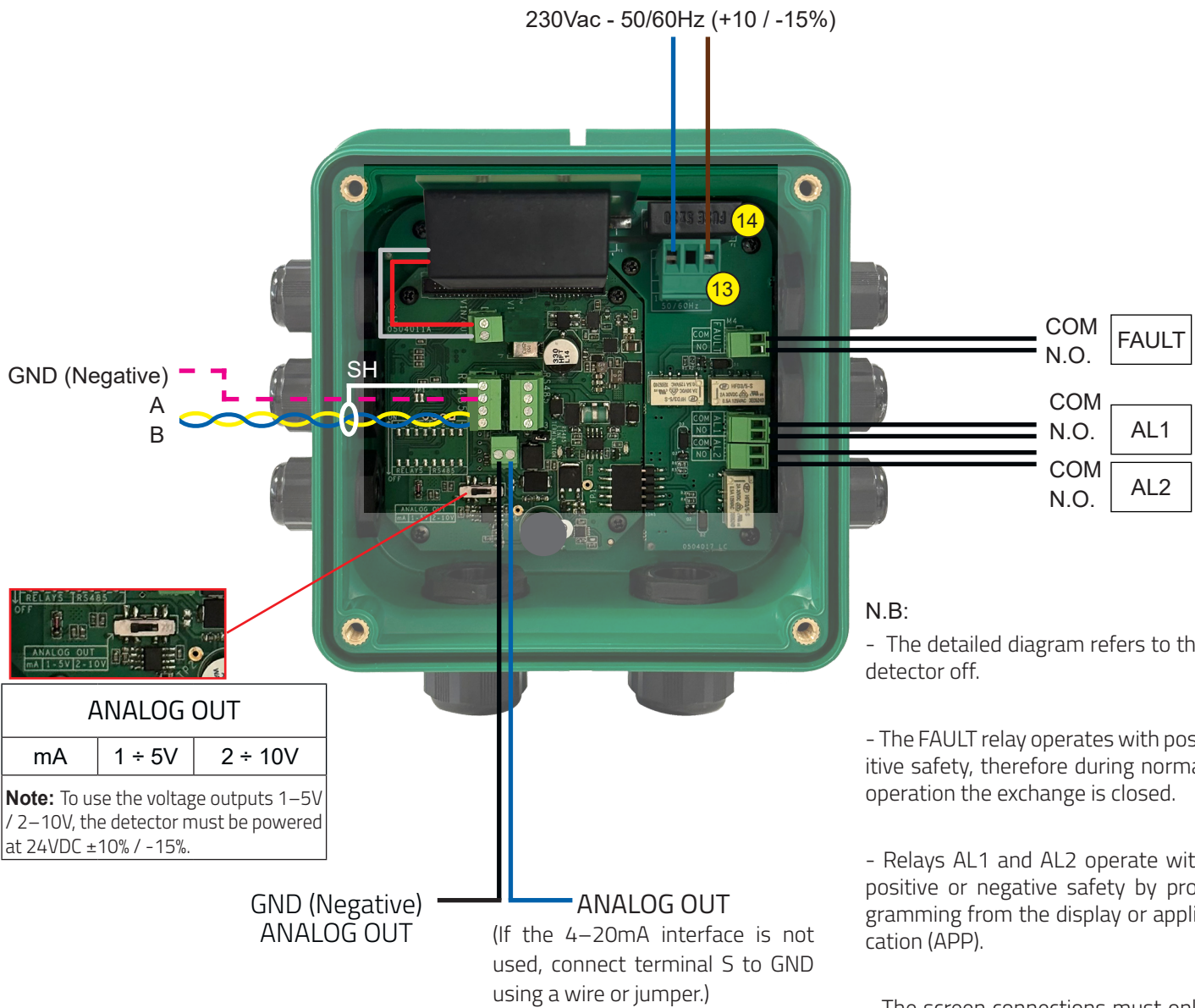

- N.B:
- The detailed diagram refers to the detector off.
 - The FAULT relay operates with positive safety, therefore during normal operation the exchange is closed.
 - Relays AL1 and AL2 operate with positive or negative safety by programming from the display or application (APP).
 - The screen connections must only be earthed on the central side.
 - For power supply and ANALOG OUT signal wiring, use shielded cables. For the RS485 BUS, it is recommended to use BELDEN 9841 cable or an equivalent.

Fig.4

Details of GDR series connections with remote sensor

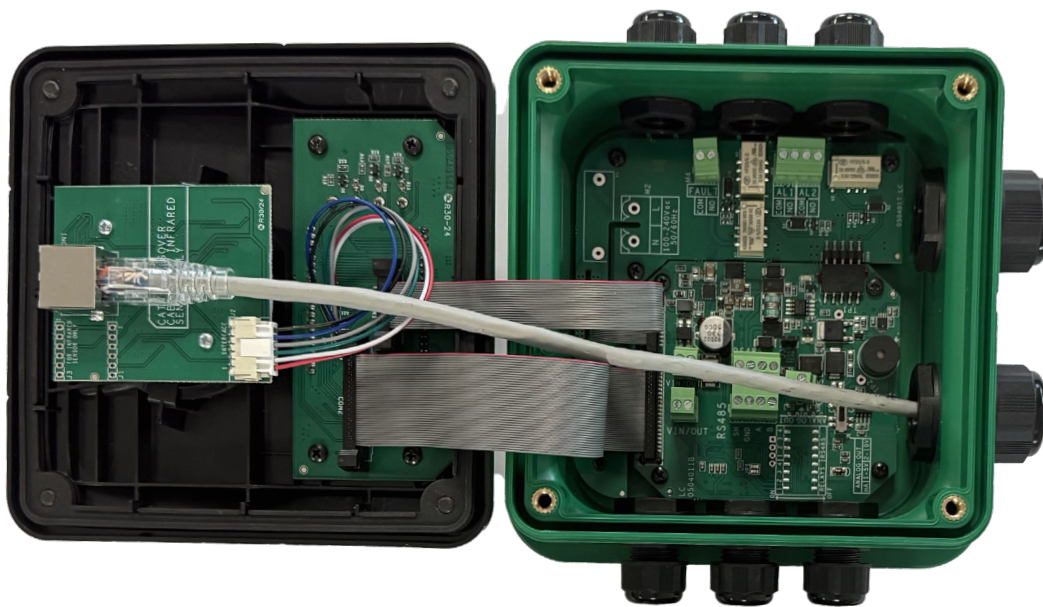

Models without display:
GDR403
Models with display:
GDR453

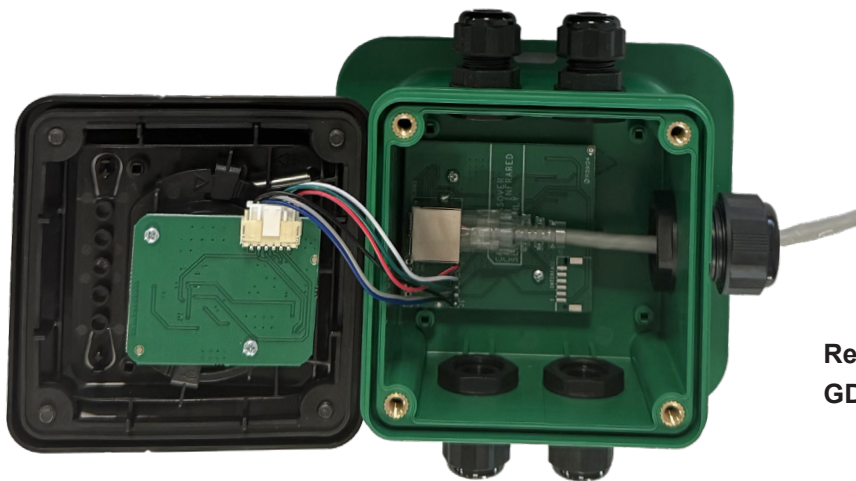

Remote sensor:
GDR

Fig.5

N.B.:

- The cable detailed in the figure for LAN connection is not provided.
- For sensors with infrared technology use an RJ45 CROSSOVER cable.
- For sensors with Pellistor, Catalytic, Cell and Semiconductor technology use a STANDARD RJ45 cable.
- Maximum cable length RJ45 3 m

3 - **DESCRIPTION**

3.1 - **PRODUCT DESCRIPTION**

GDR Refrigerant gas detector



GDR model refrigerant gas detectors (halocarbons) are used in centralised alarm systems for refrigerant gas industries, laboratories, cylinder storage warehouses, compressor rooms, and environments where it is necessary to monitor any refrigerant gas leaks. The code of each model identifies the type of gas detected, its full scale and the possibility of having the display. The device consists of a case containing the electronic circuit and the connection terminal blocks.

The user interfaces on the front cover are detailed below:





GDR450/453 - Refrigerant gas detector with LCD display keys  and .



GDR400/403- Refrigerant gas detector without display with keys  and .



GDR300 - Refrigerant gas detector without display with keys  and .



GDR403/453 - Remote Sensitive Unit.

The "Replaceable Sensor Cartridge" is housed in the Sensor Holder, which contains the sensitive element with the identification and calibration data for the specific gas detected.

To ensure that the activation of the button is recognised, exert a pressure for about one second (Pressure reception is displayed by the brief flashing of the green LED ()).

The LEDs indicate the operating conditions:

LED AL1 AL2 red () "ALARM": Optical alarm signalling or special states.

LED green () "ON": Normal operation.

LED yellow () "FAULT": Sensor faulty or disconnected or full scale or expired or special state

LED blue () "BLUETOOTH": Off-> Bluetooth module off; Flashing -> Bluetooth module ON waiting to connect to remote device; Fixed ON -> connection made with remote device.

For a detailed description of the LEDs, consult the appropriate chapter.

3.2 - **OPERATION OF SENSOR TECHNOLOGIES**

The "Pellistor" catalytic combustion sensor is not very sensitive to changes in humidity and temperature. The calibration is carried out for a single specific gas, but also detects other flammable gases or solvents, if present in the same room.

The semiconductor sensor (MOS) offers excellent sensitivity to the gas to be detected, even at very low concentrations. Its use avoids potential problems or economic damages due to a possible refrigerant gas leak. The semiconductor sensor has a good resistance to poisoning, but can be affected by the variation of environmental parameters (temperature and humidity) and has a rather low selectivity (sensitivity to other refrigerant gases or interfering gases such as solvents, engine exhaust gases, hydrocarbons, hydrogen).

If the influence on the environmental parameters can be compensated by auto-zero systems of the detector, the interference of other gases temporarily present in the environment (e.g. vehicle exhaust gases) can be improved by setting appropriate delays in the activation of the alarms. The low selectivity to halocarbons can however be exploited in the monitoring of environments or plants, where leaks of different refrigerant gases are possible.

The electrochemical sensors used are temperature compensated, but are sensitive to extreme humidity variations. The calibration is carried out with the specific gas, but it is sensitive to also other gases, if present in the same room.

The NDIR sensor is temperature-compensated, can be used in polluted environments without having a significant degradation of performance even in the long term and also works in oxygen-deficient environments. The operation of the NDIR sensor is based on the physical principle that certain gases absorb certain wavelengths of infrared energy. In practice, a filament generates infrared energy, which concentrated passes through the gas to be measured and reaches the detector. The detector is double: the first, defined as "active", has a specific optical filter for the gas to be measured, while the second, called "reference" has a different filter to provide the value of "zero". The signal difference between the two detectors is the gas concentration value. This technique is selective especially for gases such as carbon dioxide, which is difficult to measure with other systems and also has the advantage of compensating for changes in sensor sensitivity over time. The only cause of interference can be the presence of water vapour that absorbs the infrared.

3.3 - **START**

When the detector is powered up, all the LEDs light up to check that they are working properly. If the detector is equipped with a display (models GDR450 and GDR453), the following are displayed in sequence:

- all display segments are switched on.
- model
- serial number
- firmware version.

at this stage, the 4-20mA output is at 0mA, the 1-5V analogue output; 2-10V (models GDR450 and GDR453) is at 0V and the fault relay (models GDR4xx) is de-energised.

3.4 - **WARM-UP**

After the start phase has ended, the detector automatically switches to the Warm-up state. This phase serves to stabilise the sensor under operating conditions.

This phase is signalled by the flashing of the yellow LED (●) "FAULT" and lasts 120 seconds.

If the detector is equipped with a display (models GDR450 and GDR453), a decreasing counter is displayed.

During this phase, the 4-20mA output is at 0mA, the 1-5V analogue output; 2-10V (models GDR450 and GDR453) is at 0V and the fault relay (models GDR4xx) is de-energised.

3.5 - **AUTOTEST**

Once the warm-up phase is finished, the detector switches to the Autotest mode, where the integrity of the internal memories and the correct functioning of the detector are automatically tested. This phase lasts for about 5 seconds, and is represented by the flashing of the green LED. If the detector is equipped with a display (models GDR450 and GDR453), the writing AUTOTEST is displayed. The autotest function is repeated automatically every 24 hours.

3.6 - **NORMAL OPERATION**

After the warm-up and the autotest function is finished, the detector switches to the normal operating state, represented by the fixed green LED (●) light, while the yellow LED (●) is OFF.

In this mode, the sensor is in normal operation, the analogue output and the digital outputs are active, the "FAULT" relay is energised. If the detector is equipped with a display (models GDR450 and GDR453), the detected gas identification and the concentration are displayed on it. The backlight is white.

NOTE:

On first start-up, wait at least 2 hours to allow the sensor to adapt to environmental conditions, then perform the "Zero Calibration" (see "MAINTENANCE") (only for catalytic sensors, for other sensors, perform it only if you notice a non-zero concentration in clean air).

4 - **ALARM/FAULT CONDITIONS**

For GDR300 detectors:

When the pre-set alarm thresholds are exceeded, the corresponding red LED (●) flashes. Once the gas concentration falls back below the threshold, accounting for a pre-set hysteresis value, the corresponding red LED (●) turns off.

For GDR4xx detectors:

If the gas concentration exceeds the configured alarm thresholds, the red LED (●) for the corresponding alarm level turns on and the associated alarm relay is activated.

If a relay activation delay has been configured, the alarm LED will flash during the delay period, and then remain steadily lit once the corresponding alarm relay is activated.

For the product:

- refrigerant gas detector, type "GD400 and GDR403"



the configuration of the alarm thresholds is done through the Bluetooth app

For the product:

- refrigerant gas detector, type "GDR450 and GDR 453"

the configuration of the alarm thresholds is done via the display menu and via the Bluetooth App.

ATTENTION: the **AL2** alarm relay always operates in "**latch**" mode. This means that if it switches over the alarm threshold, it can be brought to the rest condition (alarm reset) only by pressing the button for three seconds:

-  **ENTER**, for detectors with display (model GDR450 and GDR453).
-  for blind case detectors (models GDR300, GDR400 and GDR403).

It is possible to reset the alarm only if the detected gas concentration is below 20% of the alarm threshold. The **latch** function is not present if only the alarm threshold **AL1** is exceeded.

When the alarm threshold **AL2** is exceeded, the built-in buzzer (GDR4xx models only) sounds.

4.1 - **Over-range condition:**

In case of very high refrigerant gas leaks exceeding 100% of full scale, the sensor enters the Over Range mode. This mode is represented by turning on all the LEDs, the 4÷20mA output is brought to 24mA (or that in port voltage to 6V if 1÷5V or 12V in the case of 2÷10V only GDR4xx models), if the relays are present (GDR4xx models) these results are all switched (with FAULT relay de-energized).: If the detector is equipped with a display (model "GDR450 and GDR453"), the **FS+** icon and the error code E012 are displayed.

NOTE for Pellistor, Electrochemical and Semiconductor (MOS) sensors:

Pellistor (catalytic), electrochemical and semiconductor (MOS) sensors require the presence of oxygen to detect combustible gases. In case of very high fuel gas leaks exceeding 100% LEL, the sensor response is no longer proportional to the concentration, due to oxygen deficiency. If the gas concentration is very high, the sensor may be completely inhibited, returning zero concentration. The **Over** Range mode is a safe mode that guarantees the signalling of gases even in case of sensor's inhibition. This condition remains until operator intervention.

To exit the **Over range** condition (Perform this type of operation in a clean area):



- press the ENTER button (for GDR450 and GDR453) or  (for GDR300, GDR400 and GDR403) for 3 seconds, the detector switches to FAULT mode.
- Perform the verification procedure (**Bump Test**) to verify the correct operation of the detector or the **span Calibration**.

NOTE for Pellistor, Electrochemical and Semiconductor (MOS) sensors:

Concentrations beyond full scale can damage the sensor, which is why Bump- p-Test or span Calibration is necessary whenever the sensor is working beyond full scale conditions.

 **CAUTION:** Make sure that the gas has been eliminated in the area before leaving the **Over Range** function and **perform** the Bump-test or **Span Calibration**. Failure to follow this warning may result in serious injury or death.

4.2 - **Warning:**

If the display shows  (GDR 450 and GDR453 models only) and the yellow LED () lights up every 5 seconds (with the green LED ()) on): the "**Sensor Cartridge**" has exceeded its life time limit and its correct operation is no longer guaranteed. The detector continues to work normally, but it is necessary to replace the "**Sensor Cartridge**" with a new one as soon as possible.

NOTE: It is always the installer's responsibility to track the lifespan of the installed sensor cartridge, regardless of the detector's warning indication. Please note that some cartridges (e.g., those with electrochemical sensors) expire even when the detector is turned off. Furthermore, environments with frequent power surges can compromise the sensor's lifespan within the cartridge.

| Warning Code | Cause | Possible solution |
|--------------|---|---|
| W001 | End-of-life sensor cartridge (this is also indicated by the yellow LED flashing every 5 seconds). | Replace the sensor cartridge as soon as possible. |
| W002 | Maximum operating temperature exceeded. | Perform the sensor span calibration (full calibration), or |
| W003 | Minimum operating temperature exceeded. | Conduct a bump test using a calibration gas to verify the sensor's proper functioning and the accuracy of the calibration (this operation must be carried out under the full responsibility of the operator). |

The warning code is visible only on the display or via the RS485 interface or the App (where a description of the issue is provided). For devices without a display, RS485, or App, only the end-of-life sensor warning can be detected, indicated by the yellow LED () flashing every 5 seconds.

4.3 - **FAULTS:**

They are indicated on the Display (GDR450 and GDR453 models), by permanently lighting the yellow LED () and bringing the "S" output to 0mA (or 0V if 1.5V or 2-10V voltage output, GDR 4xx models) and deactivating the FAULT relay (GDR 4xx models).

| Error code | Cause | Possible solution |
|------------|---|---|
| E001 | Internal program memory error. | - Send the detector to the supplier for repair. |
| E002 | Internal data memory error. | |
| E003 | Internal RAM error | |
| E004 | Internal RAM memory error. | - Replace the sensor cartridge. |
| E005 | Generic sensor cartridge error. | - Replace the sensor cartridge. - If the problem persists, send the detector to the supplier for repair. |
| E006 | Sensor cartridge communication error. | - Check the wiring connections to the sensor cartridge. - Verify that the sensor cartridge is correctly installed. - If the problem persists, send the detector to the supplier for repair. |
| E007 | Sensor signal acquisition circuit error. | - Replace the sensor cartridge. |
| E008 | Supply voltage error for the sensitive element. | - Replace the sensor cartridge. - If the problem persists, send the detector to the supplier for repair. |
| E009 | Incorrect sensor cartridge model. | - Replace the sensor cartridge with the correct model for the installed detector. |
| E010 | Sensor cartridge replaced without powering off and on the detector. | - The sensor cartridge must be replaced only when the detector is powered off. - Power off and then power on the detector. |
| E011 | Sensor under-range error (sensor detects a gas concentration below the measurable range). | - Attempt to perform the sensor span calibration. - If the problem persists, replace the sensor cartridge. |
| E012 | Sensor over-range error (sensor detects a gas concentration above the full scale). | - Perform the sensor span calibration (full calibration), Or - Conduct a bump test using calibration gas to verify proper sensor operation and correct calibration. - If the problem persists, replace the sensor cartridge. |
| E013 | 4–20mA signal generation error. | - Verify the correct connection of the 4–20mA interface. - If the 4–20mA interface is not used, connect terminal S to GND with a wire or jumper. - If the problem persists, send the detector to the supplier for repair. |
| E014 | Internal voltage reference error. | - Send the detector to the supplier for repair. |
| E015 | Alarm relay AL1 error. | |
| E016 | Alarm relay AL2 error. | |
| E017 | Dip-switch configuration error. | - An unauthorized Dip-Switch configuration has been set. - Check the configuration. |
| E018 | Generic error. | - Send the detector to the supplier for repair. |

5 - **MENU AND PASSWORD** (GDR450 AND GDR453)

The detector has a series of menus, accessible from the display, which allow it to be configured and maintained.

To access the menu, from the normal operation screen, touch the key .

You can scroll through the menu items using the key , while you can confirm the item displayed with the **ENTER** key .

The main menu has the following items:

- **INFO:** Displays detector information.
- **LANGUAGE:** Setting the display language (access by level 1 password).
- **CONFIG:** Access to the detector configuration menu (access by level 2 password).
- **MAINTENANCE:** Access to the detector maintenance menu (access by level 2 password).
- **MODIF PSW:** Management of the level 1 and level 2 passwords.
- **EXIT:** Back to normal operation screen.

5.1 - **MANAGING OF THE PASSWORDS**

Access to some functions of the detector is password-protected. The passwords are of 2 levels:

- level 1: user password. Allows access to the language setting menu on the display and the connection of the smartphone to the detector (in the case of Bluetooth connection).

- level 2: operator password. Allows access to all the configuration and maintenance functions of the detector (see main menu).

NOTE: The factory set password is "0000" for both level 1 and level 2.

It is recommended to change the password instead of using the factory default one when putting the detector into service.

The password is entered, when required by the protected menus, using buttons on the display

The password is entered using the button:

-  : to scroll the selected digit (flashing)

-  : allows you to go to the next digit.

Once you have finished entering your current password, confirm it by touching the  **ENTER** key for at least 2 seconds. If the password is correct, you automatically have access to the protected menu, alternatively the ERR message is displayed.

NOTE: When the password of the corresponding level is entered, you can access all the menus protected by the same password level for one hour without having to re-enter it each time. During the duration of this time, the KEY symbol  flashes.

5.2 - **PASSWORD CHANGING**

To change the password, go to the main menu and scroll down to the **MODIF PSW** item.

Confirm entry to the password sub-menu by pressing the  **ENTER** key.

In the **MODIF PSW** menu, scroll with the button  until you select the password you want to change:

- LEVEL 1: change the level 1 password
- LEVEL 2: change the level 2 password.

Confirm the password you wish to change by pressing the  **ENTER** key.

When the level password you want to change is confirmed, you are initially required to enter the current password. The password is entered using the button:

-  : scroll the selected digit (flashing).

-  : allows you to go to the next digit.

Once you have finished entering your current password, confirm it by touching the  **ENTER** key for at least 2 seconds. If the password entered is correct, the screen for entering the new password is displayed.

The procedure is the same used to enter the current password. Once the new password has been entered, confirm it by touching the  **ENTER** key for at least 2 seconds.

6 - **LANGUAGE SELECTION**

To change the language on the display, go to the main menu and scroll to the **LANGUAGE** item.

Confirm entry to the password sub-menu by pressing the  **ENTER** key.

In the **LANGUAGE** menu, scroll with the button  until you select the language you want to set:

Confirm the language you wish to change by pressing the  **ENTER** key.

7 - **DETECTOR CONFIGURATION (GDR450 and GDR453) WITH DISPLAY**

ATTENTION: For the GDR400/403/300 models (WITHOUT DISPLAY) the configuration is carried out via APP.

The detector configuration is carried out by accessing the Configuration menu (**CONFIG**) starting from the main menu (see menu chart).

ATTENTION: To access the configuration menu it is necessary to enter the level 2 password.

The configuration menu has the following items:

- **INFO SENS:** allows viewing the data present in the memory of the sensor cartridge
- **GPS SETTING:** setting of the gas to be detected (for detectors with a pellistor sensor that allow it)
- **RELAY:** setting the alarm relays (optional)
- **RS485-** Address and bitrate setting of the RS485 interface (optional)
- **BLUETOOTH:** Activation and deactivation of the Bluetooth module (optional)
- **BACK:** return to main menu.

7.1 - **SENSOR CARTRIDGE DATA DISPLAY (INFO SENS)**

This function allows viewing the data saved in the memory of the sensor cartridge.

To access the function, access the configuration menu (**CONFIG**) and scroll down to the **INFO SENS** item.

Confirm entry by pressing the  **ENTER** key.

You can scroll through all the data on the sensor cartridge using the key .

The data shown are:

- Identification value of the detected gas cartridge model.
- Name of the gas to be used for **Span Calibration**
- Gas concentration used during the last **Span Calibration**
- Zero calibration **ADC value**.
- Span Calibration **ADC value**.
- Temperature detected during **Zero Calibration**.
- Temperature measured during **Span calibration**.
- Number of **Span Calibrations** performed.
- Remaining hours of sensor life at the time of the last **Span Calibration**.
- Residual hours of sensor life.
- maximum temperature detected.
- minimum temperature detected.
- maximum gas concentration detected.

(Some values may or may not be present depending on the cartridge installed).

You can return to the configuration menu by touching the key  on the "**BACK**" item.

7.2 - **SETTING THE GAS TO BE DETECTED (GAS SETTING)** (available only on detectors with Pellistor sensor (catalytic)).

In this menu you can set, for cartridges compatible with the detection of multiple gases at the same time, the gas you want to detect. The selection of the gas automatically sets the detector so that its response is linear to the concentration and compensated to the environmental parameters.

To set the gas to be detected, access the main menu and scroll down to the **GAS SETTING** item.

Confirm entry to the sub-menu by pressing the  **ENTER** key.

Within the **GAS SETTING** menu, scroll with the button  until you select the gas you want to set:

Confirm the gas you want to set by pressing the  **ENTER** key.

ATTENTION: When confirming the gas to be set, the detector restarts automatically to set itself correctly for the detection of the new gas.

NOTE: if, by scrolling in the gas setting menu, there is only one gas, it means that the installed cartridge is enabled to only detect the displayed gas.

7.3 - RELAY ALARM SETTING

In the relay sub-menu, you can set:

- the operating LOGIC of the alarm relays which can be "**Positive**": relay energised in the absence of an alarm and de-energised in the presence of an alarm; "**Negative**": relay de-energised in the absence of an alarm and energised in the presence of an alarm.

ATTENTION: For greater safety, it is recommended to set the "positive" operating logic.

NOTE: The operating logic of the fault relay (FAULT) is always "**Positive**" (not settable), that is, in the absence of a fault it is normally energized, while in the presence of a fault it is de-energized.

- Alarm threshold (THRESHOLD): concentration value beyond which the corresponding alarm relay must switch.

NOTE 1: the alarm threshold values can be configured between a minimum value and a factory preset maximum value according to current regulations.

NOTE 2: The alarm threshold value 2 (**AL2**) must necessarily be higher than the threshold value set for **AL1**.

- Activation delay (SEC DELAY): for each of the two alarm thresholds, a corresponding relay activation delay expressed in seconds is possible from the moment the threshold is exceeded.

WARNING: for applications complying with EN 50676 performance, it is necessary to set the activation delay to zero (zero seconds).

NOTE: the activation delay values can be set between a minimum and a maximum factory preset value.



To access the relay settings, access the configuration menu (**CONFIG**) and scroll down to the item **RELAY**.

Confirm entry by pressing the  **ENTER** key. At the input of the relay setting interface, the first thing that is asked to be set is the operating logic (**Positive** or **Negative**).



Scroll with the button  until you select the logic you want to set:



Confirm the logic you wish to change by pressing the  **ENTER** key.

When the operating logic of the alarm relays is confirmed, it is requested to enter the alarm activation threshold **AL1**. The threshold is entered by means of buttons:

-  : allows you to scroll the selected digit (flashing).
-  : allows you to go to the next digit.

Once the **AL1** activation threshold has been entered, confirm it by touching the  **ENTER** key for at least 2 seconds. When the insertion of the alarm threshold **AL1** is confirmed, it is requested to enter the activation delay of the alarm **AL1** . The delay is entered using buttons:

-  : allows you to scroll the selected digit (flashing).
-  : allows you to go to the next digit.

Once the **AL1** activation delay has been entered, confirm it by touching the  **ENTER** key for at least 2 seconds. At this point, the alarm threshold and the **AL2** activation delay are entered. The procedure is the same used for **AL1** . Once all the values have been entered, you can save the set configuration or return to the previous menu. Scroll with the key  to select the option **SAVE** or **RETURN**.

Confirm the choice by pressing the  **ENTER** key.

7.4 - SETTING RS485

In the RS485 sub-menu, you can set:

- the ADDRESS assigned to the detector for digital communication (Modbus, or BUS). It can be set from 1 to 247.

ATTENTION: be careful not to set the same address to multiple detectors within the same network.

- **BAUDRATE:** represents the communication speed in bits per second.

NOTE: In particularly electromagnetically disturbed environments, it may be convenient/necessary to reduce the communication speed in order to minimize reception errors.

To access the RS485 interface settings, access the configuration menu (CONF) and scroll down to the RS485 item. Confirm access by pressing the  ENTER key.

At the access of the RS485 setting interface, the first thing that is asked to be set is the address to be assigned to the detector.

Entering the address by means of buttons:

-  : allows you to scroll the selected digit (flashing)

-  : allows you to go to the next digit.

Once the address has been entered, confirm it by touching the  ENTER key for at least 2 seconds.

Scroll with the key  until you select the speed you want to set from those available.

Confirm the speed you wish to change by pressing the  ENTER key.

Once all the values have been entered, you can save the set configuration or return to the previous menu.

Scroll with the key  to select the option SAVE or RETURN.

Confirm the choice by pressing the  ENTER key.

7.5 - ENABLING/DISABLING BLUETOOTH

In this, you can enable or disable the bluetooth module inside the detector, in order to make communication with the Tecnocontrol App possible.

To enable/disable the Bluetooth module, go to the main menu and scroll down to the BLUETOOTH entry.

Confirm access to the sub-menu by pressing the  ENTER key.

Within the BLUETOOTH menu, scroll with the key  to select whether you want to enable it (ON) or disable it (OFF). Confirm by pressing  ENTER.

NOTE: Communication with the Tecnocontrol App is only available with the bluetooth module in **ON** mode.

NOTE 2: The password to enter on the App when connecting to the detector, is the level 1 password.

NOTE 3: The detector with display and without display can be configured by means of a special **App**.

8 - DETECTOR MAINTENANCE

Maintenance of the detector is performed by accessing the maintenance menu (manutenz) from the main menu for the version with display.

For the version without display, the use of the key sequence detailed in the following chapters applies.

ATTENTION: To access the maintenance menu it is necessary to enter the level 2 password (**see PASSWORD chapter**).

The following items are present in the maintenance menu:

- **ELECTR TEST:** allows you to test the display (**GDR450 and GDR453 only**), LEDs and relays (optional).
- **SPAN SPAN:** setting of the concentration of sample gas to carry out **span Calibration** (optional for sensor cartridges that allow it).
- **CALIBR ZERO:** performs the detector zero calibration.
- **CALIBR SPAN:**
 - performs the complete calibration of the detector (performs the **zero calibration** first and then the **Span** calibration with sample gas in sequence).
 - **NOTE: Span Calibration** is not possible in GDRxxxIC250 detectors. If after the Bump Test the sensor is found to be outside the accuracy specifications, contact the manufacturer.
- **BUMP TEST:** used to carry out the gas operation test of the detector. In this mode, the activation of the relays (if any) is deactivated.
- **RETURN:** return to **main menu**.

8.1 - ELECTRICAL TEST

"ELECTRICAL TEST" allows to carry out the functional test of the LEDs (apart from the Bluetooth LED), of the relays (optional of the detector) and of the display (**only model GDR450 and GDR453**) and the ANALOG OUT.





| LED STATUS | OUTPUT STATUS during the ELECTRICAL TEST GDR450/453 – GDR400/403 – (GDR300 4–20mA only) | | | | | | |
|-----------------------|--|--------|---------|--------|------------|----------|----------|
| | 4÷20mA | 1÷5Vdc | 2÷10Vdc | BUZZER | RELE FAULT | RELE AL1 | RELE AL2 |
| (●) FAULT | 0 mA | 0Vdc | 0Vdc | OFF | OFF | *OFF | *OFF |
| (●) ON | 4 mA | 1Vdc | 2Vdc | OFF | ON | *OFF | *OFF |
| (●) AL1 | 20 mA | 5Vdc | 10Vdc | OFF | ON | *ON | *OFF |
| (●) AL1+ AL2 | 24 mA | 6Vdc | 12Vdc | ON | ON | *ON | *ON |

* Switching occurs according to the configured logic (positive or negative relay safety).

The display segments (**model GDR450 and GDR453 only**) are all on.

During the TEST phases, the backlighting of the display will change color depending on the states.

You can enter this mode:

- **model GDR300, GSR400, GDR403** : insert the sequence    .
- **model GDR450, GDR453:** access the configuration menu (MAINTENANCE) and scroll down to the ELECTRICAL TEST ITEM. Confirm entry by pressing the  **ENTER** key.

To exit this method

- **model GDR300, GSR400, GDR403** press button .
- **model GDR450, GDR453** : press **ENTER** button.

Setting span calibration concentration (GDR450, GDR453 only)

In this section, you can set the sample gas concentration value (see "calibration gas" table) to be provided to the sensor during **span Calibration**. The name of the type of gas to be supplied is published on the display.

Calibration Gas Table

| CODE | Precision | Measuring range | Response time | Sensor lifespan | Resolution | Relative humidity | Operating temperature | Calibration gas |
|-------------------------------|----------------|-----------------|---------------|-------------------|------------|-------------------------------|--|---|
| ELECTROCHEMICAL SENSOR | | | | | | | | |
| GDRxxxEA | ± 5% FS | 0+1000 ppm | T90 ≤ 45 Sec. | 2 years clean air | 1 ppm | 15+90% Non cond. | -40°C + +50°C | 100 ppm NH3 in Synthetic Air Flow 0,5Lt/Min |
| GDRxxxEAH | ± 5% FS | 0+100 ppm | T90 ≤ 45 Sec | 2 years clean air | 1 ppm | 15+90% Non cond. | -40°C + +50°C | 100 ppm NH3 in Synthetic Air Flow 0,5Lt/Min |
| GDRxxxEO | ± 2% FS | 0+25% vol. | T90 ≤ 15 Sec | 2 years clean air | 0,1% Vol. | 5+95% Non cond. da 0°C a 20°C | -20°C + +50°C up to 3 continuous months over the entire RH range | Ambient Air/Synthetic Air (20.9%Vol OXYGEN) Flow 0,5Lt/Min |
| PELLISTORE SENSOR | | | | | | | | |
| GDRxxxPX | ± 5% FS | 0+100% LFL | T90 < 30 Sec | 5 years clean air | 1% LFL | 0+95% Non cond. | -40°C + +60°C | 50% LFL Methane in Synthetic Air - Flow 0,3Lt/Min |
| INFRARED SENSOR | | | | | | | | |
| GDRxxxIC25 | * ± 5% FS | 0+5000 ppm | T90 < 60 Sec. | 5 years clean air | 10 ppm | 0+95% Non cond. | -40°C + +60°C | 2500 ppm CO2 in Nitrogen Flow 0,5Lt/Min |
| GDRxxxIC210 | * ± 5% FS | 0+1% vol. | T90 < 60 Sec | 5 years clean air | 0,01% Vol | 0+95% Non cond. | -40°C + +60°C | 0,5% Vol. CO2 in Nitrogen Flow 0,5Lt/Min |
| GDRxxxIC220 | * ± 5% FS | 0+2% vol. | T90 < 60 Sec | 5 years clean air | 0,01% Vol | 0+95% Non cond. | -40°C + +60°C | 1% Vol. CO2 in Nitrogen Flow 0,5Lt/Min |
| GDRxxxIC250 | * ± 5% FS | 0+5% vol. | T90 < 60 Sec | 5 years clean air | 0,01% Vol | 0+95% Non cond. | -40°C + +60°C | 2,5% Vol. CO2 in Nitrogen ONLY FOR BUMP TEST |
| GDRxxxI1 | * ± 5% FS | 0+100%LFL | T90 < 30 Sec | 5 years clean air | 1 %LFL | 0+95% Non cond. | -40°C + +60°C | 50% LFL n-Propane in Synthetic Air/Nitrogen, Flow 0,5Lt/Min |
| GDRxxxI2 | * ± 5% FS | 0+100%LFL | T90 < 30 Sec | 5 years clean air | 1 %LFL | 0+95% Non cond. | -40°C + +60°C | 50% LFL n-Butane in Synthetic Air/Nitrogen, Flow 0,5Lt/Min |
| GDRxxxI3 | * ± 5% FS | 2000 ppm | T90 < 30 Sec | 5 years clean air | 4 ppm | 0+95% Non cond. | -40°C + +60°C | 1000 ppm Gas R407C in Synthetic Air - Flow 0,5Lt/Min |
| GDRxxxI4 | * ± 5% FS | 2000 ppm | T90 < 30 Sec | 5 years clean air | 4 ppm | 0+95% Non cond. | -40°C + +60°C | 1000 ppm Gas R410A in Synthetic Air - Flow 0,5Lt/Min |
| GDRxxxI5 | * ± 5% FS | 2000 ppm | T90 < 30 Sec | 5 years clean air | 4 ppm | 0+95% Non cond. | -40°C + +60°C | 1000 ppm Gas R507 in Synthetic Air - Flow 0,5Lt/Min |
| GDRxxxI6 | * ± 5% FS | 2000 ppm | T90 < 30 Sec | 5 years clean air | 4 ppm | 0+95% Non cond. | -40°C + +60°C | 1000 ppm Gas R449A in Synthetic Air - Flow 0,5Lt/Min |
| GDRxxxI7 | * ± 5% FS | 2000 ppm | T90 < 30 Sec | 5 years clean air | 4 ppm | 0+95% Non cond. | -40°C + +60°C | 1000 ppm Gas R32 in Synthetic Air - Flow 0,5Lt/Min |
| GDRxxxI8 | * ± 5% FS | 2000 ppm | T90 < 30 Sec | 5 years clean air | 4 ppm | 0+95% Non cond. | -40°C + +60°C | 1000 ppm Gas R134A in Synthetic Air - Flow 0,5Lt/Min |
| GDRxxxI9 | * ± 5% FS | 2000 ppm | T90 < 30 Sec | 5 years clean air | 4 ppm | 0+95% Non cond. | -40°C + +60°C | 1000 ppm Gas R404A in Synthetic Air - Flow 0,5Lt/Min |
| GDRxxxIX | * ± 5% FS | 0+2000 ppm | T90 < 30 Sec | 5 years clean air | 4 ppm | 0+95% Non cond. | -40°C + +60°C | On request - Flow 0,5Lt/Min |
| SEMICONDUCTOR SENSOR | | | | | | | | |
| GDRxxxS3 | -10 / +15 % FS | 0+1000 ppm | T90 < 90 Sec. | 5 years clean air | 1 ppm | 0+95% Non cond. | -20°C + +50°C | 1000 ppm Gas R407C in Synthetic Air - Flow 0,3Lt/Min |
| GDRxxxS4 | -10 / +15 % FS | 0+1000 ppm | T90 < 90 Sec. | 5 years clean air | 1 ppm | 0+95% Non cond. | -20°C + +50°C | 1000 ppm Gas R410A in Synthetic Air - Flow 0,3Lt/Min |
| GDRxxxS5 | -10 / +15 % FS | 0+1000 ppm | T90 < 90 Sec. | 5 years clean air | 1 ppm | 0+95% Non cond. | -20°C + +50°C | 1000 ppm Gas R507 in Synthetic Air - Flow 0,3Lt/Min |
| GDRxxxS6 | -10 / +15 % FS | 0+1000 ppm | T90 < 90 Sec. | 5 years clean air | 1 ppm | 0+95% Non cond. | -20°C + +50°C | 1000 ppm Gas R449A in Synthetic Air - Flow 0,3Lt/Min |
| GDRxxxS7 | -10 / +15 % FS | 0+1000 ppm | T90 < 90 Sec. | 5 years clean air | 1 ppm | 0+95% Non cond. | -20°C + +50°C | 1000 ppm Gas R32 in Synthetic Air - Flow 0,3Lt/Min |
| GDRxxxS8 | -10 / +15 % FS | 0+1000 ppm | T90 < 90 Sec. | 5 years clean air | 1 ppm | 0+95% Non cond. | -20°C + +50°C | 1000 ppm Gas R134A in Synthetic Air - Flow 0,3Lt/Min |
| GDRxxxS9 | -10 / +15 % FS | 0+1000 ppm | T90 < 90 Sec. | 5 years clean air | 1 ppm | 0+95% Non cond. | -20°C + +50°C | 1000 ppm Gas R404A in Synthetic Air - Flow 0,3Lt/Min |
| GDRxxxSX | -10 / +15 % FS | 0+1000 ppm | T90 < 90 Sec. | 5 years clean air | 1 ppm | 0+95% Non cond. | -20°C + +50°C | On request - Flow 0,3Lt/Min |

* ± 1% FS for readings at 25% range (Values at 25°C and 1000 hPa pressure)

± 2% FS for readings at 50% range (Values at 25°C and 1000 hPa pressure)

± 5% FS for all readings above 50% range (Values at 25°C and 1000 hPa pressure)

8.2 - SETTING THE CALIBRATION CONCENTRATION

WARNING: Models with display GDR450 and GDR453 (for all PELLISTOR and ELECTROCHEMICAL sensors except the Oxygen sensor) the calibration concentration value can be set between a minimum and a preset maximum value. If it is not possible to change the value shown on the display, it means that the sensor cartridge is not enabled to change the concentration value of **span Calibration** (See table in chapter 13).

To access the **Span Calibration** concentration setting, enter the maintenance menu (MAINTENANCE) and scroll down to the "GAS SPAN" item. Confirm by pressing the  ENTER key.

The **span Calibration** concentration is entered using the buttons:

 allows you to scroll through the selected digit (flashing).

 allows you to go to the next digit.

Once the concentration has been entered, confirm by pressing the  ENTER key for at least 2 seconds.

8.3 - ZERO CALIBRATION

Allows you to manually adjust the value of zero in clean air (**environment without the presence of gases or other pollutants**).

WARNING: For infrared (NDIR) sensors, it is always recommended to perform a full span calibration, not just a zero calibration. Zero calibration can only be performed at temperatures close to the previous span calibration (if the sensor has never been calibrated, consider 20°C-30°C).

For infrared (NDIR) and oxygen sensors, it is necessary to perform the procedure using a synthetic air or nitrogen cylinder, adjusting the gas flow between 0.3 and 0.5 L/min.

For all sensors, perform this operation only if necessary and at least 2 hours after powering up.

Models with display GDR450 and GDR453

To access the **Zero Calibration** function, enter the maintenance menu (MAINTENANCE) and scroll down to the CALIBR ZERO item. Confirm by pressing  ENTER key.

For zeroing procedures, follow the flow chart below.

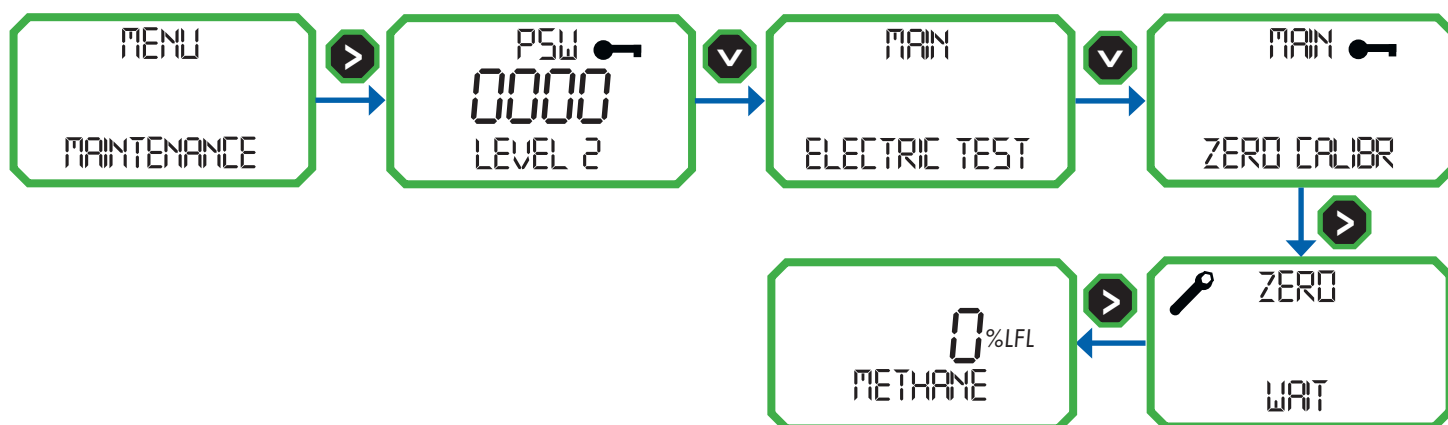

The AL1 (●) and FAULT (●) LEDs start flashing and the WAIT message is shown on the display.

Note for Infrared (NDIR) sensors: supply gas to the sensor from a Synthetic Air or Nitrogen cylinder and adjust the gas flow between 0.3 and 0.5 L/min.

The detector automatically evaluates the stability of the value read by the sensor. The completion of the **Zero Calibration** is represented by the display of the CALIBR OK message and the fixed switching on of the AL1 (●) and FAULT (●) LEDs for 5 seconds. After the calibration is finished, the detector returns to normal operation.

CAUTION: See "Notes" section on the next page.

8.5 - MODELS WITHOUT DISPLAY GDR300, GDR400 and GDR403

Proceed by pressing the keys following the sequence below **F2**, **F1**, **F1**, **F2**.

The AL1 (●) and FAULT (●) LEDs start flashing.

Note for Infrared (NDIR) sensors: supply gas to the sensor from a *Synthetic Air* or *Nitrogen* cylinder and adjust the gas flow between 0.3 and 0.5 L/min.

The detector automatically evaluates the stability of the read value.

The completion of **Zero Calibration** is represented by the fixed ignition of LEDs AL1 (●) and FAULT (●) for 5 seconds. After the calibration is finished, the detector returns to normal operation.

NOTES:

- In this mode, the 4÷20mA output is set to 0mA, the voltage output (GDR4xx models) is set to 0V, while the FAULT relay (**GDR4xx models**) is de-energised.

- if there is a minimum concentration of refrigerant or interfering gases in the environment, perform the calibration using a cylinder of synthetic air (**describe part of the calibration cap**).

- If LEDs AL1 (●) and FAULT (●) continue to flash and the word **WAIT** or **WAIT GAS** remains on the display, it means that the value detected by the sensor is not constant. Carry out the calibration with a cylinder of synthetic air. (**describe part of the calibration cap**).

- If the LEDs AL1 (●) and FAULT (●) continue to flash and the display shows the word **HIGH**, it means that the sensor is reading a signal too high to perform the calibration.

This may be caused by:

- 1) In the presence of gas above **10%LFL** (or interfering gas) in the environment. In this case, perform **Zero Calibration** using a synthetic air cylinder and **Calibration cap**.
- 2) The sensor is damaged. In this case, replace the sensor cartridge.

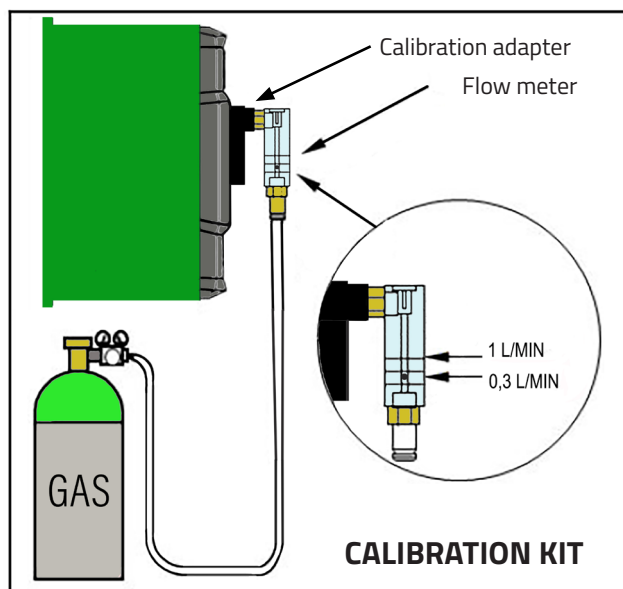

WARNING: Adjust the gas flow rate between 0.3 and 0.5 L/min.

You can exit the Zero Calibration function at any time (cancelling the procedure):

- For models GDR300, GDR400, and GDR403: by pressing the **F2** button.
- For models GDR450 and GDR453: by pressing the **> ENTER** button.

8.6 - SPAN CALIBRATION

NOTE: Span Calibration is not possible in GDRxxxIC250 detectors. If after the Bump Test the sensor is found to be outside the accuracy specifications, contact the manufacturer.

Span calibration refers to the full calibration (except for OXYGEN SENSORS) of the detector, which includes zero calibration followed by calibration using a reference gas.

It is possible to exit the zero calibration function at any time (canceling the procedure) :

- For model GDR300/400/403 by pressing **F2** key.
- For model GDR450/453 by pressing **>** ENTER key.

If the detector is equipped with an INFRARED sensor and the span calibration sequence does not perform **zero calibration** beforehand, exit the **span calibration** using the button **F2** or **>** ENTER, and carry out the zero calibration procedure before performing the span calibration.

Furthermore, both span and zero calibrations must be performed under the same environmental conditions. Failure to comply with this note may result in a significant deterioration of sensor accuracy.

8.6.1 - MODEL WITH DISPLAY (GD450/453)

To enter the **span calibration** on the model with display, access the maintenance menu (MANUTENZ) and scroll to the CALIBR SPAN option. Confirm entry by pressing the **>** button.

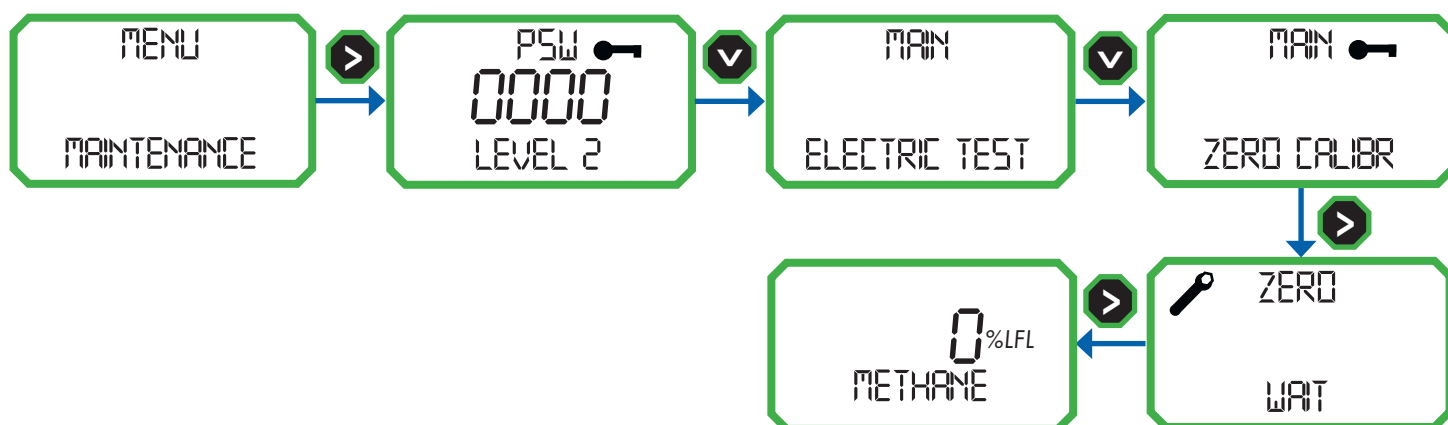

The diagram shows an example of span calibration of a Methane sensor with INFRARED technology cartridge. The detector first performs zero calibration (as described in paragraph 9), (with the exception of OXYGEN) when the zero calibration is completed, the detector automatically switches to **span calibration**.

NOTE: If the detector has an INFRARED SENSOR and the span sequence does not pre-**calibrate the zero**, exit the **span calibration** using the **>** key and perform the **zero calibration** procedure before performing the **span calibration**.

The FAULT (●) and AL2 (●) LEDs start flashing and the display shows the words WAITING GAS with the expected concentration value. Apply the appropriate **Calibration adapter KIT** to the front of the detector in the appropriate housing. Adjust the gas flow between **0,3** and **0,5 L/min** depending on the sample gas listed in the **Calibration Gas Table** on the previous pages.

When the sensor detects gas, the display shows "WAIT".

The detector automatically evaluates the stability and correctness of the detected value.

Wait (about 3 minutes) until, when the FAULT (●) and AL2 (●) LEDs remain STEADY, the word CALIBR OK / REMOVE GAS is displayed.

At this point, the calibration was successful, so remove the CALIBRATION KIT from the front of the detector, close the cylinder and wait for it to return to normal operation (maximum 3 minutes).

CAUTION: See "Notes" section on the next page.

8.6.2 - MODEL WITHOUT DISPLAY (GDR300/GDR400/403)

To enter **span calibration** on models without a display, perform the following sequence using the keys:



The detector first performs zero calibration (as described in paragraph 9), (with the exception of OXYGEN) when the zero calibration is completed, the detector automatically switches to span calibration.

NOTE: If the detector has an INFRARED sensor and the span sequence does not pre-calibrate the zero, exit the **span calibration** by pressing the **F2** button and perform the **zero calibration** procedure before performing the **span calibration**.

The FAULT (●) and AL2 (●) LEDs start flashing. Apply the appropriate CALIBRATION KIT as shown in the figure below on the front of the detector in the appropriate housing. Adjust the gas flow between **0.3 and 0.5 L/min** using the sample gas detailed in the Calibration Gas Table on the previous pages.

Wait (maximum 3 minutes) until the FAULT (●) and AL2 (●) LEDs remain STEADY.

At this point, the calibration was successful, so remove the Calibration adapter KIT from the front of the detector, close the cylinder and wait for it to return to normal operation (maximum 3 minutes).

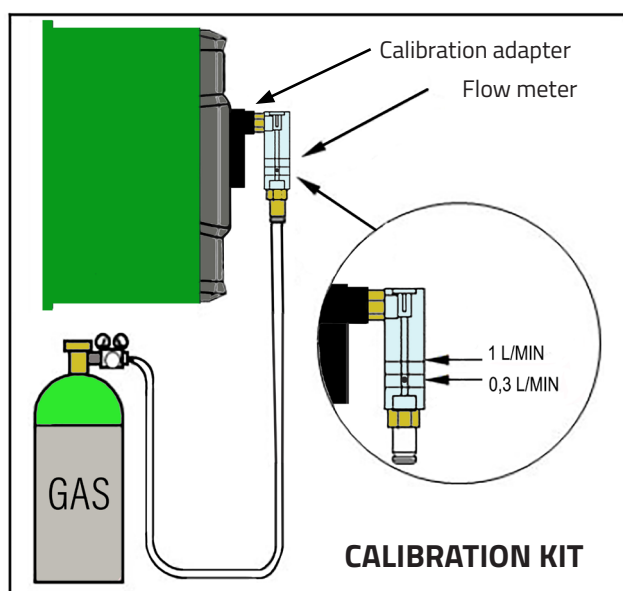

Notes:

- Regardless of the gas detected, the gas to be used for calibration is that used from the "Calibration Gas Table" on the previous pages.
- Although some sensors allow the setting of the gas concentration to carry out the span calibration, it is advisable to carry out the calibration at the concentration proposed in the "Calibration gas table" in order to obtain the best performance.
- In this mode, the 4 +20mA output is brought to 0mA, while the FAULT relay (if present) is de-energised.
- If AL2 (●) and FAULT (●) LEDs continue to flash and on the display (GDR450 and GDR453) or APP the text WAITING GAS remains, it means that the gas flow is not constant or is insufficient or the concentration is not as expected.
- If AL2 (●) and FAULT (●) LEDs continue to flash and on the display (GDR450 and GDR453) or APP the text WAIT remains, it means that the gas flow is not constant.
- If AL2 (●) and FAULT (●) LEDs continue to flash and on the display (GDR450 and GDR453) or APP displays the text HIGH, it means that the gas concentration supplied is higher than expected.
- For oxygen sensors, calibration can be performed using ambient air, ensuring that the oxygen concentration in the environment is **20.9% vol**. Do not breathe near the sensor during calibration.

9 - **BUMP TEST** Verification of operation in gas (Bump-Test)

The VERIFICATION allows you to test the correct operation of the sensor and the interface of the detector. In this mode, the alarm relays are disabled (if present).

In this mode it is possible to provide the sensor with a known concentration of titrated gas from titrated cylinder in synthetic air and verify that the detected value is equal to the expected value.

The bump test is a state that lasts for a maximum of 15 minutes, after which the detector automatically switches to normal operation.

To enter the **Bump test**:

9.1 - **MODEL WITH DISPLAY (GDR450/453)**

Access the maintenance menu (MAINTENANCE) and scroll down to the **Bump test**.

Confirm the entry by pressing the  key.





The display (GDR450/453 model) shows the text CHECKING sample gas with the detected value and the remaining time counter in seconds.

In this mode the LEDs FAULT (●), ON (●) and AL1(●) flash.

Apply the appropriate Calibration adapter KIT to the front of the detector in the appropriate housing.

Adjust the gas flow between **0,3** and **0,5 L/min** using the sample gas detailed in the Calibration Gas Table on the previous pages. Wait (about 3 minutes, check the correct response of the detector through the 4÷20mA current output). The **Bump test** operation ends automatically 15 minutes after the start of the test or by pressing the  **ENTER** key.

9.2 - **MODEL WITHOUT DISPLAY (GDR300/400/403)**

Press the keys in the detailed sequence , , , .

In this mode the LEDs FAULT (●), ON (●) and AL1(●) flash.

Apply the appropriate Calibration adapter KIT to the front of the detector in the appropriate housing.

Adjust the gas flow between 0.3 and 0.5 L/min using the sample gas detailed in the **Calibration Gas Table** on the previous pages. Wait (about 3 minutes, check the correct response of the detector through the 4 ÷ 20mA current output).

The Bump test operation ends automatically 15 minutes after the start of the test or by pressing the  key .

NOTES:

- In this mode, the output 4÷20mA and RS485 work regularly, the FAULT relay (if present) is energized, the relays AL1 (●) and AL2 (●) do not signal any alarm.

- If the full scale concentration is exceeded, the detector switches to Over-range mode (see appropriate chapter).

9.3 - RELAY OUTPUT ALARM VALUES TABLE

| Model | Sensor Cartridge | Gas | Full scale | Default AL1 | Default AL2 | AL1 Range | AL2 Range | AL1 and AL2 hysteresis | AL1 AL2 Delay range | Gas calibration range |
|--------------------|------------------|-----------------|------------|-------------|------------------------|------------------|------------------|------------------------|---------------------|-----------------------|
| GDRxxxEA | ZSREA | NH3 | 1000 ppm | 50 ppm | ELECTROCHEMICAL SENSOR | 50 - 899 ppm | 51 - 900 ppm | 10% | 0 - 99 sec | 50 - 900 ppm |
| GDRxxxEAH | ZSREAH | NH3 | 100 ppm | 10 ppm | PELLISTOR SENSOR | 10 - 99 ppm | 11 - 100 ppm | 20% | 0 - 99 sec | 20 - 100 ppm |
| GDRxxxPP - PG - PX | ZSRP | Flammable | 100 %LFL | 10 %LFL | INFRARED SENSOR | 5 - 50 %LFL | 6 - 60 %LFL | 20% | 0 - 99 sec | 20 - 50 %LFL Methane |
| GDRxxxIC25 | ZSRIC25 | CO2 | 5000 ppm | 1000 ppm | 2000 ppm | 700 - 4999 ppm | 701 - 5000 ppm | 15% | 0 - 99 sec | 2500 ppm |
| GDRxxxIC210 | ZSRIC210 | CO2 | 1.00 %vol | 0.20 %vol | 0.30 %vol | 0.07 - 0.99 %vol | 0.08 - 1.00 %vol | 10% | 0 - 99 sec | 0.50 %vol |
| GDRxxxIC220 | ZSRIC220 | CO2 | 2.00 %vol | 0.20 %vol | 0.50 %vol | 0.07 - 1.99 %vol | 0.08 - 2.00 %vol | 5% | 0 - 99 sec | 1.00 %vol |
| GDRxxxIC250 | ZSRIC250 | CO2 | 5.00 %vol | 0.20 %vol | 0.50 %vol | 0.07 - 4.99 %vol | 0.08 - 5.00 %vol | 5% | 0 - 99 sec | - |
| GDRxxxI1 | ZSRI1 | R290 (Propane) | 100 % LFL | 10 %LFL | 20 %LFL | 5 - 50 %LFL | 6 - 60 %LFL | 20% | 0 - 99 sec | 50 %LFL |
| GDRxxxI2 | ZSRI2 | R600 (n-Butane) | 100 % LFL | 10 %LFL | 20 %LFL | 5 - 50 %LFL | 6 - 60 %LFL | 20% | 0 - 99 sec | 50 %LFL |
| GDRxxxI3 | ZSRI3 | R407C | 2000 ppm | 500 ppm | 900 ppm | 100 - 1999 ppm | 101 - 2000 ppm | 15% | 0 - 99 sec | 1000 ppm |
| GDRxxxI4 | ZSRI4 | R410A | 2000 ppm | 500 ppm | 900 ppm | 100 - 1999 ppm | 101 - 2000 ppm | 15% | 0 - 99 sec | 1000 ppm |
| GDRxxxI5 | ZSRI5 | R507A | 2000 ppm | 500 ppm | 900 ppm | 100 - 1999 ppm | 101 - 2000 ppm | 15% | 0 - 99 sec | 1000 ppm |
| GDRxxxI6 | ZSRI6 | R449A | 2000 ppm | 500 ppm | 900 ppm | 100 - 1999 ppm | 101 - 2000 ppm | 15% | 0 - 99 sec | 1000 ppm |
| GDRxxxI7 | ZSRI7 | R32 | 2000 ppm | 500 ppm | 900 ppm | 100 - 1999 ppm | 101 - 2000 ppm | 15% | 0 - 99 sec | 1000 ppm |
| GDRxxxI8 | ZSRI8 | R134a | 2000 ppm | 500 ppm | 900 ppm | 100 - 1999 ppm | 101 - 2000 ppm | 15% | 0 - 99 sec | 1000 ppm |
| GDRxxxI9 | ZSRI9 | R404A | 2000 ppm | 500 ppm | 900 ppm | 100 - 1999 ppm | 101 - 2000 ppm | 15% | 0 - 99 sec | 1000 ppm |
| GDRxxxI10 | ZSRI10 | R1234ze | 2000 ppm | 500 ppm | 900 ppm | 100 - 1999 ppm | 101 - 2000 ppm | 15% | 0 - 99 sec | 1000 ppm |
| GDRxxxI11 | ZSRI11 | R1234yf | 2000 ppm | 500 ppm | 900 ppm | 100 - 1999 ppm | 101 - 2000 ppm | 15% | 0 - 99 sec | 1000 ppm |
| GDRxxxI12 | ZSRI12 | R454B | 2000 ppm | 500 ppm | 900 ppm | 100 - 1999 ppm | 101 - 2000 ppm | 15% | 0 - 99 sec | 1000 ppm |
| GDRxxxI13 | ZSRI13 | R454C | 2000 ppm | 500 ppm | 900 ppm | 100 - 1999 ppm | 101 - 2000 ppm | 15% | 0 - 99 sec | 1000 ppm |
| GDRxxxIX | ZSRIX | on request | - | - | - | - | - | - | 0 - 99 sec | - |
| | | | | | SEMICONDUCTOR SENSOR | | | | | |
| GDRxxxS3 | ZRS3 | R407C | 1000 ppm | 500 ppm | 800 ppm | 150 - 999 ppm | 151 - 1000 ppm | 20% | 0 - 99 sec | 1000 ppm |
| GDRxxxS4 | ZRS4 | R410A | 1000 ppm | 500 ppm | 800 ppm | 150 - 999 ppm | 151 - 1000 ppm | 20% | 0 - 99 sec | 1000 ppm |
| GDRxxxS5 | ZRS5 | R507A | 1000 ppm | 500 ppm | 800 ppm | 150 - 999 ppm | 151 - 1000 ppm | 20% | 0 - 99 sec | 1000 ppm |
| GDRxxxS6 | ZRS6 | R449A | 1000 ppm | 500 ppm | 800 ppm | 150 - 999 ppm | 151 - 1000 ppm | 20% | 0 - 99 sec | 1000 ppm |
| GDRxxxS7 | ZRS7 | R32 | 1000 ppm | 500 ppm | 800 ppm | 150 - 999 ppm | 151 - 1000 ppm | 20% | 0 - 99 sec | 1000 ppm |
| GDRxxxS8 | ZRS8 | R134a | 1000 ppm | 500 ppm | 800 ppm | 150 - 999 ppm | 151 - 1000 ppm | 20% | 0 - 99 sec | 1000 ppm |
| GDRxxxS9 | ZRS9 | R404A | 1000 ppm | 500 ppm | 800 ppm | 150 - 999 ppm | 151 - 1000 ppm | 20% | 0 - 99 sec | 1000 ppm |
| GDRxxxS10 | ZRS10 | R1234ze | 1000 ppm | 500 ppm | 800 ppm | 150 - 999 ppm | 151 - 1000 ppm | 20% | 0 - 99 sec | 1000 ppm |
| GDRxxxS11 | ZRS11 | R1234yf | 1000 ppm | 500 ppm | 800 ppm | 150 - 999 ppm | 151 - 1000 ppm | 20% | 0 - 99 sec | 1000 ppm |
| GDRxxxS12 | ZRS12 | R454B | 1000 ppm | 500 ppm | 800 ppm | 150 - 999 ppm | 151 - 1000 ppm | 20% | 0 - 99 sec | 1000 ppm |
| GDRxxxS13 | ZRS13 | R454C | 1000 ppm | 500 ppm | 800 ppm | 150 - 999 ppm | 151 - 1000 ppm | 20% | 0 - 99 sec | 1000 ppm |
| GDRxxxSX | ZRSX | on request | 1000 ppm | 500 ppm | 800 ppm | 150 - 999 ppm | 151 - 1000 ppm | 20% | 0 - 99 sec | 1000 ppm |

10 - DIMENSIONS and WEIGHT :

GDR 400/403 - 450/453:

- **WEIGHT GDR 400/403: 562,5g**
- **WEIGHT 450/453: 578,0 g**

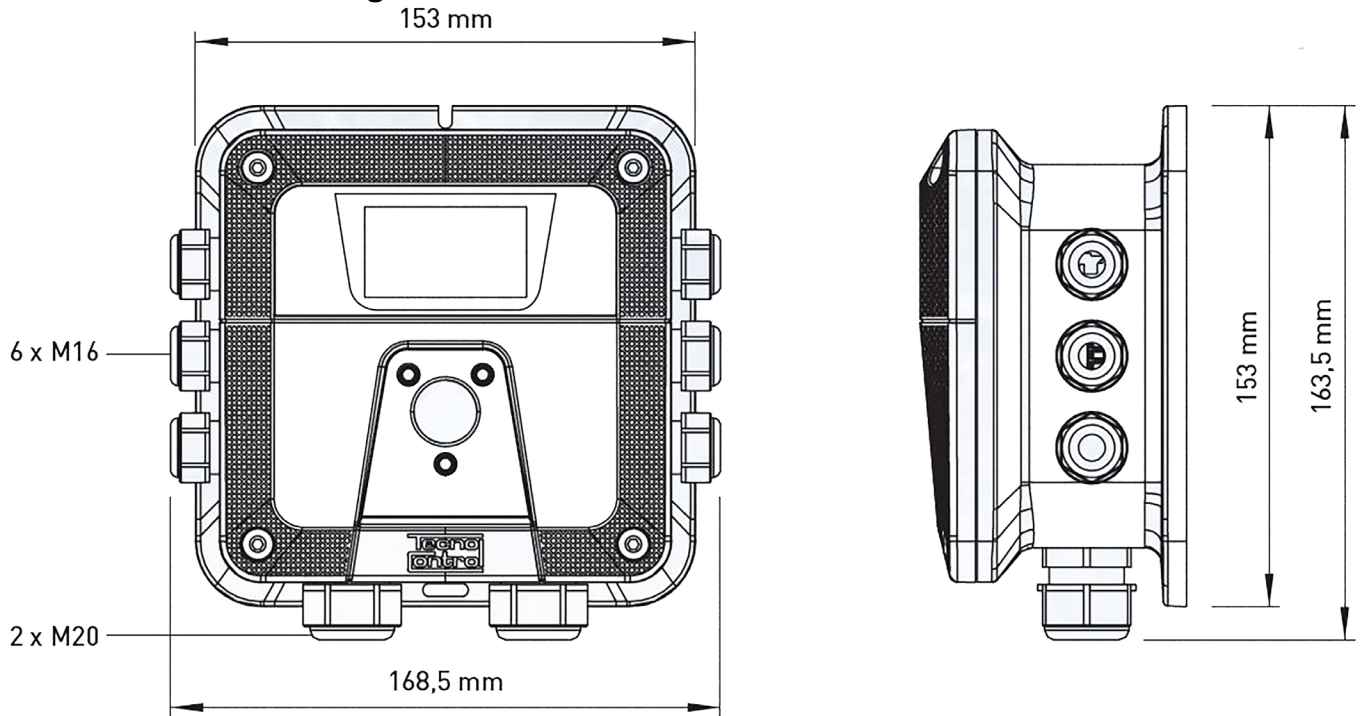

GDR300 - 453/403 (Remote sensor)

- **WEIGHT GDR300: 366,0 g**
- **WEIGHT GDR453/403: 324,0 g**

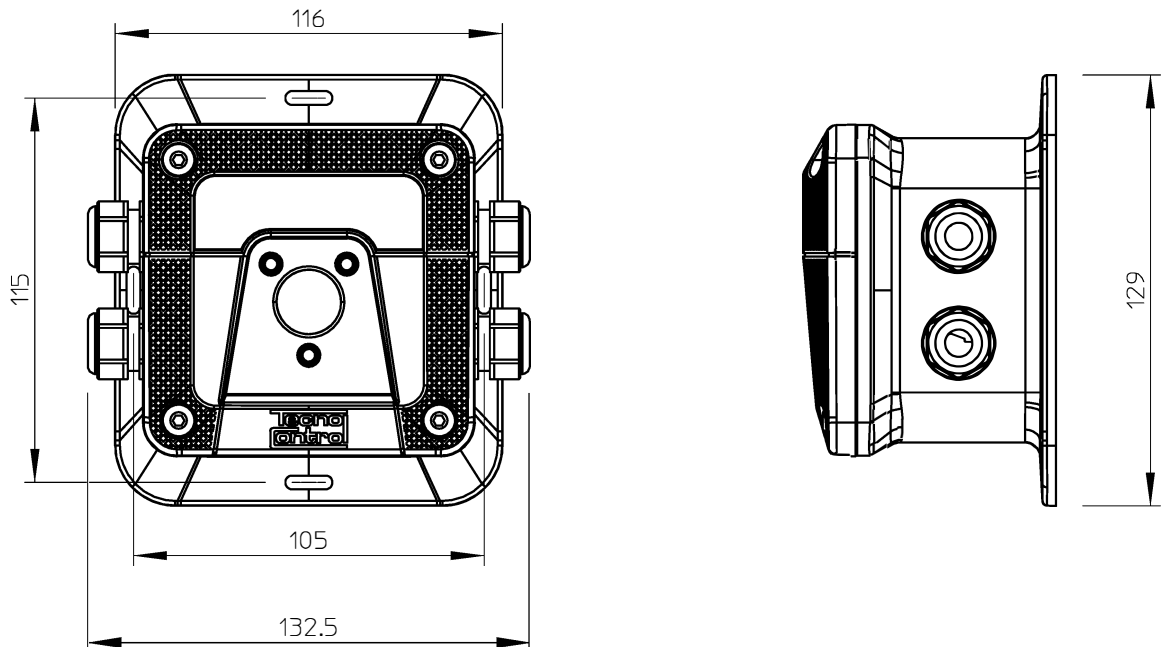

11 - TECNOCONTROL APPLICATION

Through the TECNOCONTROL application, you can easily and intuitively interface with your devices. Download the application on your **Smartphone/Tablet** using your store and proceed as follows.



11.1 - CONFIGURATION

- Power on the GDR gas detector. The display will show the GDR detector information, serial number (SN), and firmware version (FW). Then, the device enters a PREHEAT mode for 120 seconds. Once the PREHEAT phase is over, the device is ready for use.

- Configuration now continues on your **Smartphone/Tablet**.

Note: To change the language, go to your **Smartphone/Tablet** settings and select the desired one.

- Start the TECNOCONTROL application

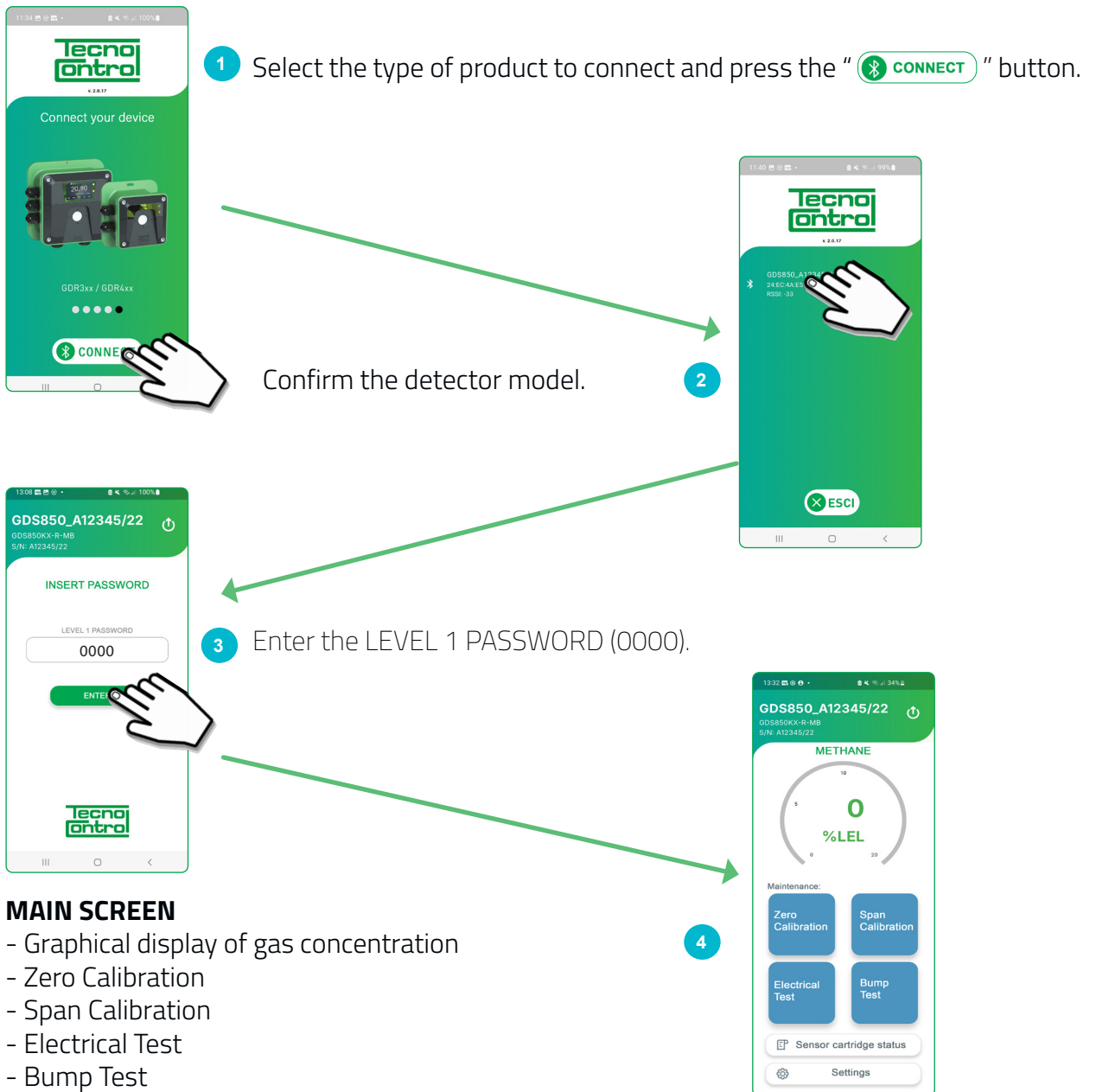



5 MAIN SCREEN:

- **Graphic display:** Graphic display of the detected gas concentration. The unit of measurement and the full scale depend on the detector used.

- **Zero Calibration** :

Allows you to manually adjust the Zero value in clean air (an environment free of gases or other pollutants).

This operation is recommended after installation or after changing the cartridge (Caution: wait at least 2 hours after turning on).

- **Span Calibration** :

Span calibration means the complete calibration of the detector which includes zero calibration and subsequent calibration with sample gas (for the sample gas refer to the detector technical manual).

- **Test Elettrico** :

It allows you to perform the functional test of the LEDs, relays (optional for the detector) and display (only model GD*450/453**). In this mode, the LEDs light up in sequence, from yellow to the 2nd red which corresponds to the activation of the relays (relay "FAULT" with the YELLOW LED, relay "AL1" with the 1st RED LED, relay "AL2" with the 2nd RED LED).

- **Bump Test** :

CHECK allows you to test the correct functioning of the sensor and the detector interface.

In this mode the alarm relays are disabled (if present).

In this mode, a known concentration of sample gas can be supplied to the sensor.

The **Bump test** is a state that lasts for up to **15 minutes**, after which the detector automatically switches to normal operation.

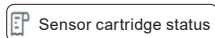

This screen contains all the configuration parameters of the sensor cartridge.



7 Settings

Enter the LEVEL 2 PASSWORD "0000" (we suggest changing the password "0000" after the first installation using the "Change Password" button).

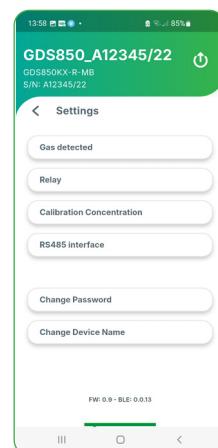
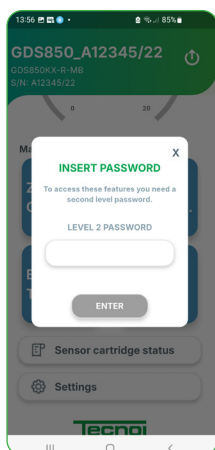

This screen contains the configuration menus listed below:

- Detected gas
- Relays
- Calibration concentration
- RS485 Interface
- Change Password
- Change Device Name
- Detector Firmware Version



| | |
|---|--|
|  | INSTRUCTION LEAFLET |
| | PAPER COLLECTION |
| | Check the regulations of your municipality |

DIRECTIVE 2012/19/UE (Waste from Electrical and Electronic Equipment - WEEE):



WEEE

Information for users:

The label with the crossed-out wheeled bin symbol indicates that the product must not be disposed of with normal domestic waste. To avoid causing damage to the environment and human health, separate this product from other domestic waste so that it can be recycled in compliance with environmental protection procedures. For more details on available collection centers, please contact local government offices or the seller of the product.

Follow us on:





cpfgroup.it



Tecnocontrol Srl
Via Miglioli, n°47 20054 Segrate (MI) Italy
Tel. +39 02 26922890
tecnocontrol.it



The manufacturer firm reserves the right to make any aesthetic or functional modification to the without prior notice at any time.

Dis. 0534061e Cod. 2.7.10.3888